

Maintenance Library

**Tools and Test Equipment, Volume 1
Parts Catalog**

PREFACE

Part Number and Description of detail parts are shown below Assembly Part Number on illustrated pages, and indented to the right.

In some cases, the illustration does not exactly represent the item. Illustrations are not always updated to show the latest modifications to the article represented.

* Indicates World Trade Corporation Use Only.

** Indicates Capital Equipment.

First Edition (January 1973)

This Tools and Test Equipment issue Form S131-0037-0, obsoletes and replaces Form S123-0330-7.

Second Edition (August 1973)

This edition of the Tools and Test Equipment, Volume 1, Form S131-0037-1, is a major revision of, and obsoletes, Form S131-0037-0.

Requests for copies of IBM publications should be made to your IBM representative or to the IBM branch office serving your locality.

This manual has been prepared by the IBM Systems Development Division, Publications Center, Dept. E01, P.O. Box 12195 Research Triangle Park, N.C. 27709.

A form is provided at the back of this publication for reader's comments. If the form has been removed, comments may be sent to the above address.

Tool Case Assemblies	Group 1
Drills, Reamers, Taps	Group 2
Wrenches, Key and Socket	Group 3
Hammers, Screwdrivers	Group 4
Pliers, Tweezers	Group 5
Files, Stones, Hacksaws, Abrasives	Group 6
Pullers, Extractors, Grippers, Vises, Punches, Hooks	Group 7
Gauges, Aligners, Adjusting Tools, Timing Tools	Group 8
Measuring Tools, (Mechanical)	Group 9
Miscellaneous Tools	Group 10
Cleaning Tools, Brushes	Group 11
Oilers, Grease Guns	Group 12
Soldering Tools	Group 13
Relay Tools	Group 14
SMS Tools	Group 15
SLT/MST and other Technology Tools	Group 16
Oscilloscope and Accessories, Test Leads, Tips, Carts	Group 17
Meters	Group 18
Testers and Test Equipment, CE Cables, Plugs, Tapes	Group 19
Test Control Panels and Test Decks	Group 20
Tool Kits	Group 21
Containers, Cases, Boxes, Cans	Group 22
Field Supplies (Lubricants, Adhesives, Etc.)	Group 23
Numerical Index	Group 24

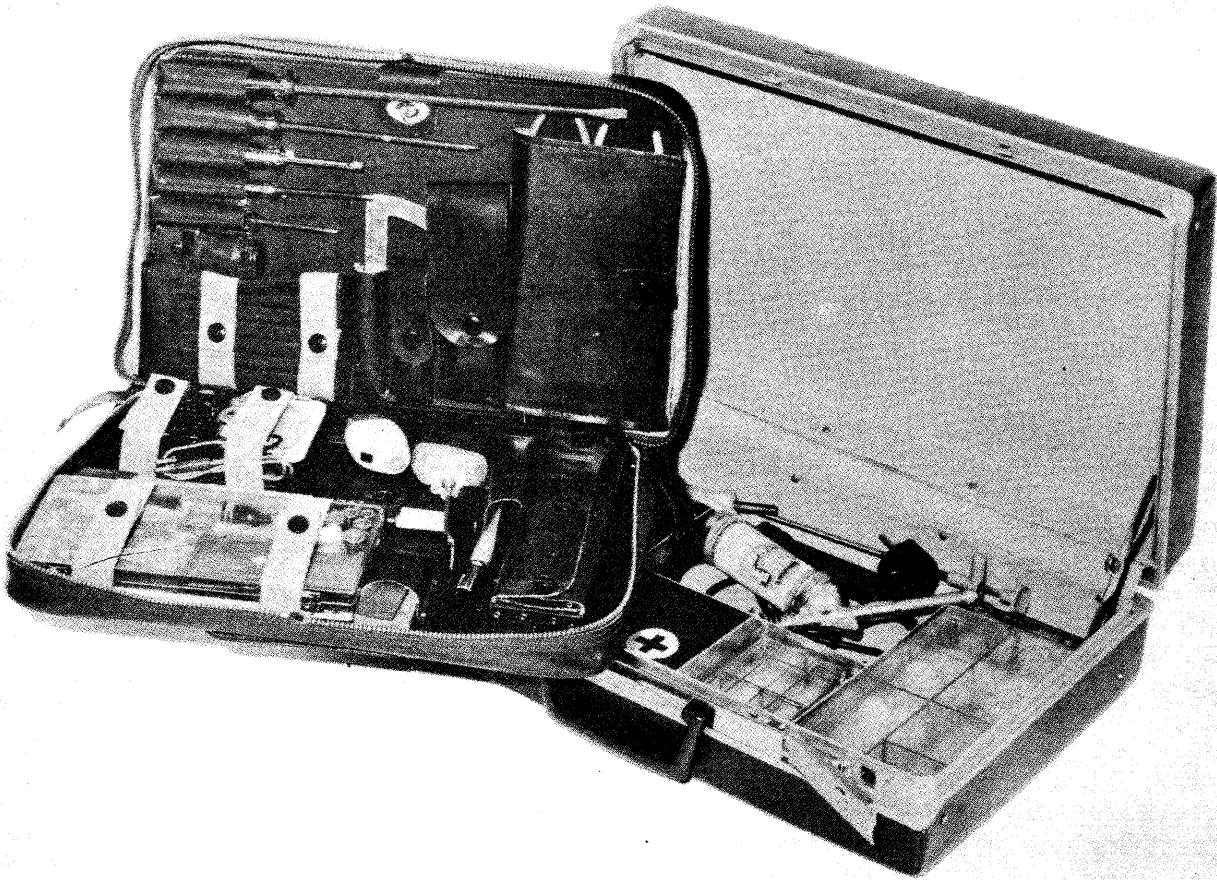

*4261105 WT CE Tool Case, Assembly, DP

	Units per Asm.		Units per Asm.
*4261102		TOOL CASE	450465
*4261148		TOOL CASE FRAME INSERT	450466
		TOOL SET, DP	
		CONSISTING OF	
3339	1	CLEANER, CHUTE BLADE	450494
3991	1	DRILL, NO. 32 2,95 MM	450495
3996	1	DRILL, NO. 19 4,20 MM	450503
4008	1	TAP THREADING, 6-32 UNC 3,51 MM	450504
4009	1	TAP THREADING, 8-32 UNC 4,17 MM	450529
4010	1	TAP THREADING, 10-32 UNF 4,83 MM	450540
4011	1	FILE, 6 IN MILL, MEDIUM	450566
4013	1	FILE, 6 IN HALF ROUND MEDIUM	450567
4014	1	FILE, 6 IN ROUND, MEDIUM	450619
4028	1	PLIERS, DIAGONAL CUTTING, 6 IN	450638
4031	1	CENTER PUNCH	450713
4032	1	PUNCH, DRIVE PIN, 1/8 X 10 IN	450732
4035	1	PUNCH, DRIVE PIN, .187 X 4 IN	450745
4047	1	ROD, BRASS, .3125 HEX-6 IN	450842
8957	1	REAMER, NO. 2, TAPER	450843
10480	1	GAUGE, CARD FEED KNIFE, GO-NO GO	451135
18463	1	STONE, SHARPENING	
18974	1	FILE, 6 IN PILLAR, MEDIUM	452397
18975	1	HANDLE, FILE	452796
55762	1	DRILL, NO. 48 1,95 MM	
55767	1	DRILL, NO. 28 3,55 MM	454326
55769	1	DRILL, NO. 23 3,90 MM	454352
55797	1	REAMER, NO. 2-0, TAPER	454353
55799	1	REAMER, NO. 5-0, TAPER	461228
55800	1	REAMER, NO. 6-0, TAPER	
76104	1	FIRST AID-KIT, SERVICEMANS	*489036
152759	1	WRENCH SET ASSEMBLY, SOCKET AND END	*489150
		FOR DETAIL BREAKDOWN SEE GROUP 3-5	*489185
153694	1	SCREWDRIVER, 1/8 X 4 IN BLADE	*489242
153697	1	SCREWDRIVER, 1/4 X 10 IN BLADE	*489905
153698	1	SCREWDRIVER, 1/4 X 1-1/2 IN BLADE	*489942
154230	1	SPRING HOOK	*489949
158333	1	GAUGE, CARD HOPPER	*771488
158645	1	GUN, GREASE, SMALL	1018992
165866	2	STICK, ABRASIVE	*4261006
171320	1	FINGER, MECHANICAL, FLEXIBLE	*4261076
178577	1	SCREWDRIVER, 3/32 X 4 IN BLADE	*4261080
450054	1	PULLER, DOWEL PIN, 10-32 X 5-40	*4261008
450126	1	MIRROR ASM, DENTAL	*4261089
450134	1	REAMER, NO. 3-0 TAPER	*4261101
450158	1	SCALE, POCKET, 6 IN	*4261104
450166	1	DRILL, NO. 16 4,50 MM	*4261108
450167	1	DRILL, NO. 9 5,00 MM	*4261109
450168	1	DRILL, NO. 6 5,20MM	
3989	1	DRILL NO. 36 2,70 MM	*489882
450263	1	DRILL, NO. 41 2,45 MM	*489881
450270	1	REAMER, NO. 4, TAPER	
450290	1	DRILL, NO. 30 3,25 MM	
450391	1	PUNCH, DRIVE PIN, .094 X 4 IN	
450407	1	PUNCH, DRIVE PIN, .0625 X 4 IN	* NOTE - WHEN ORDERING TOOL CASE ASM 4261105 THE DESIRED SOLDERING IRON MUST BE ORDERED SEPARATELY.
450448	1	PUNCH, DRIVE PIN, .050 X 3-1/2 IN	
450459	1	SCALE, GRAM	
		FOR DETAIL BREAKDOWN SEE GROUP 9-41	
		BOX, PLASTIC, 8 SECT. 1-1/2 X 4 X 9 IN	2
		KEY SET, HEX AND FLUTED	1
		FOR DETAIL BREAKDOWN SEE GROUP 3-13	
		PLIERS, LONG NOSE, 6 IN INSUL	1
		SCREWDRIVER, 3/16 X 6 IN BLADE	1
		STICK, EMERY POLISHING	1
		PLIERS, DRUCK BILL, 8 IN INSUL	1
		WRENCH, TAP AND REAMER EXTENSION	1
		SPRING HOOK, SMALL CROCHET	1
		EXTENSION, GREASE NOZZLE TIP	1
		FOR 158645	1
		BLADE, BURNISHING, SILVER CONTACT	2
		SCREW STARTER, HAND, 7-64 IN	1
		TUBE AND CUP, 13-26 X 2-1/8 IN PLASTIC	1
		OILER, HAND	1
		BRUSH, SASH	1
		GAUGE, THICKNESS, .001-.030 IN	1
		CLIP, ALLIGATOR, INSUL, RED	2
		CLIP, ALLIGATOR, INSUL, BLACK	2
		KIT ASM, RATCH SCREWDRIVER	1
		FOR DETAIL BREAKDOWN SEE GROUP 4-15	
		REED RELAY EXTRACTOR AND FUSE PULLER	1
		MULTIMETER ASM, VOM	1
		FOR DETAIL BREAKDOWN SEE GROUP 8-79	
		GAUGE, DUPLICATING BRUSH	1
		BOX, PLASTIC, 4 SECT, 5 X 3 X 1 IN	1
		WRENCH, ADJUSTABLE, 8 IN	1
		HANDLE AND BLADE ASSEMBLY	1
		FOR DETAIL BREAKDOWN SEE GROUP 4-15	
		HAMMER, FLAT PEEN, 5 OZ, 150 GRAMS	1
		ADJUSTING TOOL, CONTACT SPRING	1
		RULLER 200 MM, 8 IN	1
		TWEEZERS, BENT TIP	1
		PLIERS, POLYGRIP	1
		HULL, GRIPPER MAGNET	1
		GRIPPER MAGNET	1
		SOLDER	1
		BRUSH, TUPE CLEANING	1
		PROBE, BANANA PLUG CONNECTION	1
		FLASHLIGHT	1
		COUPLING, BANANA PLUG, 6-32 THREAD	4
		BOX, PLASTIC, 9 X 4 X 1 IN	1
		PLASTIC CASE, DRILL SET	1
		OIL DROPPER	1
		TOO BAG WITH ZIP 11 X 17 IN	1
		TEST LEAD 6,6 FT, RED, 6-32 THREAD	1
		TEST LEAD 6,6 FT, GREEN, 6-32 THREAD	1
		*SOLDERING IRON 115 V 16w	1
		* SOLDERING IRON 220V 16w	1



SMALL



MEDIUM



PROGRAM SUPPORT

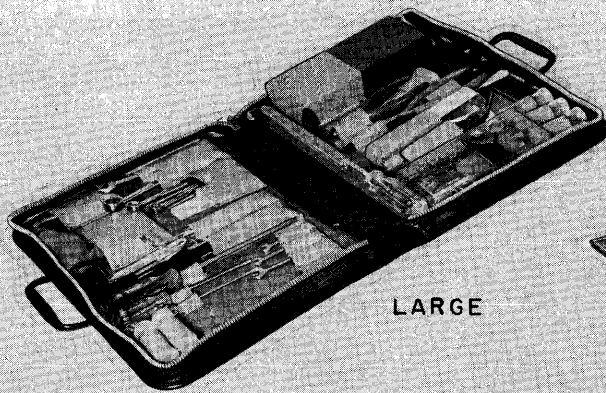

LARGE

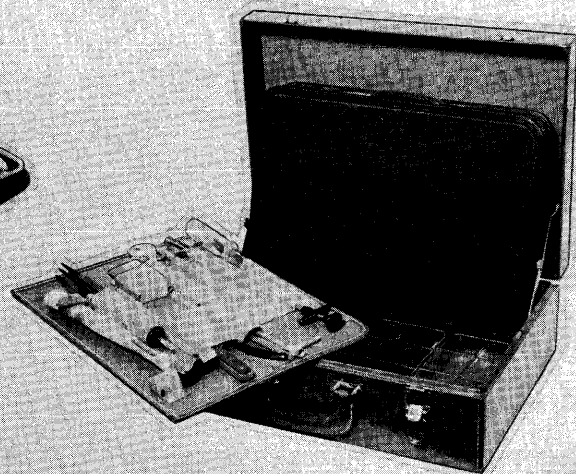

FE SMALL, MEDIUM AND LARGE TOOL KITS

		Units per Asm.			Units per Asm.	
453581	KIT, TOOL, SMALL	AR		153696	SCREWDRIVER 9/32 X 8 IN BLADE	1
	CONSISTING OF			153698	SCREWDRIVER 1/4 X 1-1/2 IN BLADE	1
450465	BOX, PLASTIC 8 SECT 1-1/2 X 4 X 9 IN	1		18463	STONE, SHARPENING	1
451556	TOOL SET A	1		454334	TIP, STRAIGHT, ROUND, SOLDERING	1
451547	CASE, TOOL, SMALL	1			FOR 454333	
453582	KIT, TOOL, MEDIUM	AR		450637	TUBE AND CAP, 7/8 X 2-1/2 IN PLASTIC	5
	CONSISTING OF			453198	PLIERS, VISE GRIP	1
450465	BOX, PLASTIC 8 SECT 1-1/2 X 4 X 9 IN	2		454353	WRENCH, ADJUSTABLE 8 IN	1
451556	TOOL SET A	1		451568	TOOL SET C	AR
451557	TOOL SET B	1			ORDER OFR DATA RECORDING CUST. ENG.	
451548	CASE, TOOL, MEDIUM	1			CONSISTING OF	
453583	KIT, TOOL, LARGE	AR		460028	ALIGNING TOOL, CODE PLATE	1
	CONSISTING OF			9900373	KEY TOP REMOVAL TOOL, SEL I/O 029/59	1
450465	BOX, PLASTIC 8 SEC 1-1/2 X 4 X 9 IN	1		2124599	LEAD, ELECT, 6 FT. RED BANANA -	2
451556	TOOL SET A	1			BELLY DANCER	
451557	TOOL SET B	1		452803	PROB, NEON, 029-59, 48 VOLT MACHINES	1
451549	CASE, TOOL, LARGE	1		1012444	ROD, FOLLOWER	1
451550	CASE, TOOL, ZIPPERED, INNER	1		450459	GAUGE, GRAM	1
451556	TOOL SET A	1		453160	TIMING TOOL, 029-59 PUNCH & VERIFIER	1
	CONSISTING OF			21213	WRENCH, SOCKET, .190 AND .221 KEYPUNCH	1
450660	BENDING TOOL, RELAY CONTACT	1		451569	TOOL SET D	AR
450667	BLADE, BURNISHING	1			ORDER FOR DATA SYSTEM CUST. ENG.	
451148	BOX, SOCKET SET, PLASTIC	1			CONSISTING OF	
450158	SCALE, 6 IN	1		10407	BENDING TOOL	1
450732	BRUSH, SASH	1		450364	BRUSH BENDING TOOL	1
453536	BRUSH, TYPE CLEANING	1		450224	BENDING TOOL, SELECTOR CONTACT	1
453514	CASE, METER	1		158333	GAUGE, CARD BUCKLE	1
452368	CLAMP, SCISSOR	1		105668	GAUGE, CHUTE BLADE .0125 - .018 IN	1
3339	CLEANER, CHUTE BLADE	1		454326	GAUGE, DUPLICATING BRUSH	1
450458	EXTENSION, TEST, WIRE CONT. RELAY	1		605901	GAUGE, SETUP RATCHET READING	1
450745	GAUGE, THICKNESS, .001-.030 IN	1		450388	JIG, BRUSH SETTING	1
450022	HOLDER ASSEMBLY, SCRIBER TOOL	1		451570	TOOL SET E	AR
154230	HOOK, SPRING	1			ORDER FOR GENERAL SYSTEMS CUST. ENG.	
450540	HOOK, SPRING, SMALL CROCHET	1			CONSISTING OF	
450466	KEY SET, HEX AND FLUTED	1		450364	BRUSH BENDING TOOL	1
	FOR DETAIL BREAKDOWN			158333	GAUGE, CARD BUCKLE	1
	SEE GROUP 3-13			454326	GAUGE, DUPLICATION BRUSH	1
451135	KIT ASSEMBLY, RATCHET SCREWDRIVER	1		856481	WRENCH, HAMMER UNIT ADJ 1403-3 & N1	1
	FOR DETAIL BREAKDOWN			450459	GAUGE, GRAM	1
	SEE GROUP 4-15				MISCELLANEOUS TOOL SETS	
450126	MIRROR ASSEMBLY, DENTAL	1		9900459	SELECTRIC I/O SETS	AR
	FOR DETAIL BREAKDOWN				ORDER FOR SELECTRIC TRAINED C.E.'S	
	SEE GROUP 10-45				CONSISTING OF	
452796	MULTIMETER, VOLT-OHMS	1		165584	4 FLUTE #4 SHIFT ASM	1
450713	OILER, HAND, VALVESPOUT	1		450813	GREASE GUN NOZZLE FOR CYCLE CLUTCH	1
4028	PLIERS, DIAGONAL CUTTING 6 IN	1		450818	SCREWDRIVER 8 IN	1
450494	PLIERS, LONGNOSE 6 IN INSUL	1		453523	GAUGE, WIRE FEELER	1
450504	PLIERS, DUCKBILL 8 IN INSUL	1		453604	TOOL, HALF CYCLE - REDUCED FUNCTION	1
461262	PROBE, BACK PANEL WIRE	1		9900427	WHEEL, OPERATIONAL INDEX	1
450054	PULLER, DOWEL PIN 10-32 NF X 5-40 NF	1		9900005	WRENCH 1/4 X 5/16 IN (SPECIAL)	1
452397	PULLER ASSEMBLY	1		9900028	6 FLUTE WRENCH #4 (ROTATE PULLEY)	1
454065	PULLER, RELAY (WC)	1		9900090	3/4 X 5/8 IN WRENCH (PIN FEED PLATEN)	1
153694	SCREWDRIVER 1/8 X 4 IN BLADE	1		9900105	SMALL SPRING HOOK	1
153697	SCREWDRIVER 1/4 X 10 IN BLADE	1		9900112	HOOVEROMETER	1
178577	SCREWDRIVER 3/36 X 4 IN BLADE	1		9900173	4 FLUTE WRENCH #2 (C1-C2)	1
450495	SCREWDRIVER 3/16 X 6 IN BLADE	1		9900190	T-BEND (FROM PUSHERS)	1
450619	SCREW STARTER, HAND 9/64 IN	1		9900200	6 FLUTE #6 WRENCH (OPERATIONAL RATCHETS)	1
165866	STICK, ABRASIVE	1		9900208	WRENCH, 3/16 X 7/32	1
450503	STICK, EMERY POLISHING	1		9900210	HOOK, SPRING-HOLDING	1
450694	STRIPPER WIDE	1		9900216	6 FLUTE WRENCH #2 (GEARLESS TILT)	1
450638	TUB AND CAP, 13/16 X 2-1/8 IN PLASTIC	5		9900226	WRENCH VELOCITY CONTROL PLATE	1
152759	WRENCH SET ASSEMBLY, SOCKET AND END	1		9900242	1/4 X 5/16 SPINTITE	1
	FOR DETAIL BREAKDOWN			9900255	6 FLUTE WRENCH # 133 (IDLER GEAR)	1
	SEE GROUP 3-9			9900266	WRENCH, 1/4 X 5/32	1
76104	FIRST AID-KIT SERVICEMAN	1		9900375	FIXTURE, DYNAMIC HALF CYCLE	1
451557	TOOL SET B			605907	TOOL SET FOR 1203 ADD UNIT	AR
	CONSISTING OF				ORDER FOR 1203 TRAINED C.E.'S	
451887	CAPLUG - FOR GREASE GUN 158645	1			CONSISTING OF	
451888	CAPLUG - FOR GREASE GUN 158645	2		460303	PUNCH, DRIVE PIN 1/8 X 8 IN SPL	1
454333	ELEMENT, SOLDERING 37W FOR 454332	1		460304	WRENCH, OPEN END, FIXED 1/4 X 14 IN	1
4011	FILE, HAND 6 IN MILL	1		460305	WRENCH, OPEN END, FIXED 5/16 X 51/6 IN	1
4013	FILE, HAND 6 MILL, HALF ROUND	1		460306	WRENCH, OPEN END, FIXED 3/8 X 3/8 IN	1
4014	FILE, HAND 6 IN ROUND	1		460307	WRENCH, OPEN END, FIXED 3/16 X 3/16 IN	1
18974	FILE, HAND 6 IN PILLER	1		460308	WRENCH, OPEN END, FIXED 7/32 X 7/32 IN	1
171320	FINGER, MECHANICAL, FLEXIBLE	1		460309	WRENCH, OPEN END, FIXED 11/32 X 11/32 IN	1
158645	GUN, GREASE, SMALL	1		460311	WRENCH, OPEN END, 1/4 IN OFFSET	1
4050	HAMMER, BALL PEEN 8 OZ	1		460312	KEY, SOCKET HD SCR, .078 IN HEX SPECIAL	1
18975	HANDLE, FILE	1		460314	WRENCH, .050 ALLEN	1
454332	HANDLE, CORD SET, SOLDERING IRON	1		460315	PUNCH, DRIVE PIN, .060 X 6 IN	1
4031	PUNCH, DRIVE PIN .094 X 4 IN	1		605902	WRENCH, 1/4 IN DOUBLE END, LONG	1
4035	PUNCH, DRIVE PIN .187 X 4 IN	1		605903	WRENCH, 1/4 IN OFFSET, T-HANDLE	1
450391	PUNCH, DRIVE PIN .094 X 4 IN	1		605904	TWEEZERS, JEWELER	1
450407	PUNCH, DRIVE PIN .0625 X 4 IN	1		605908	PUNCH, DRIVE PIN, .055 X 10.5	1
450448	PUNCH, DRIVE PIN .050 X 3-1/8 IN	1		453663	TOOL CASE, PROGRAM SUPPORT	AR
4032	PUNCH, DRIVE PIN 1/8 X 10 IN	1				
4047	ROD, BRASS .3125 HEX - 6 IN	1				

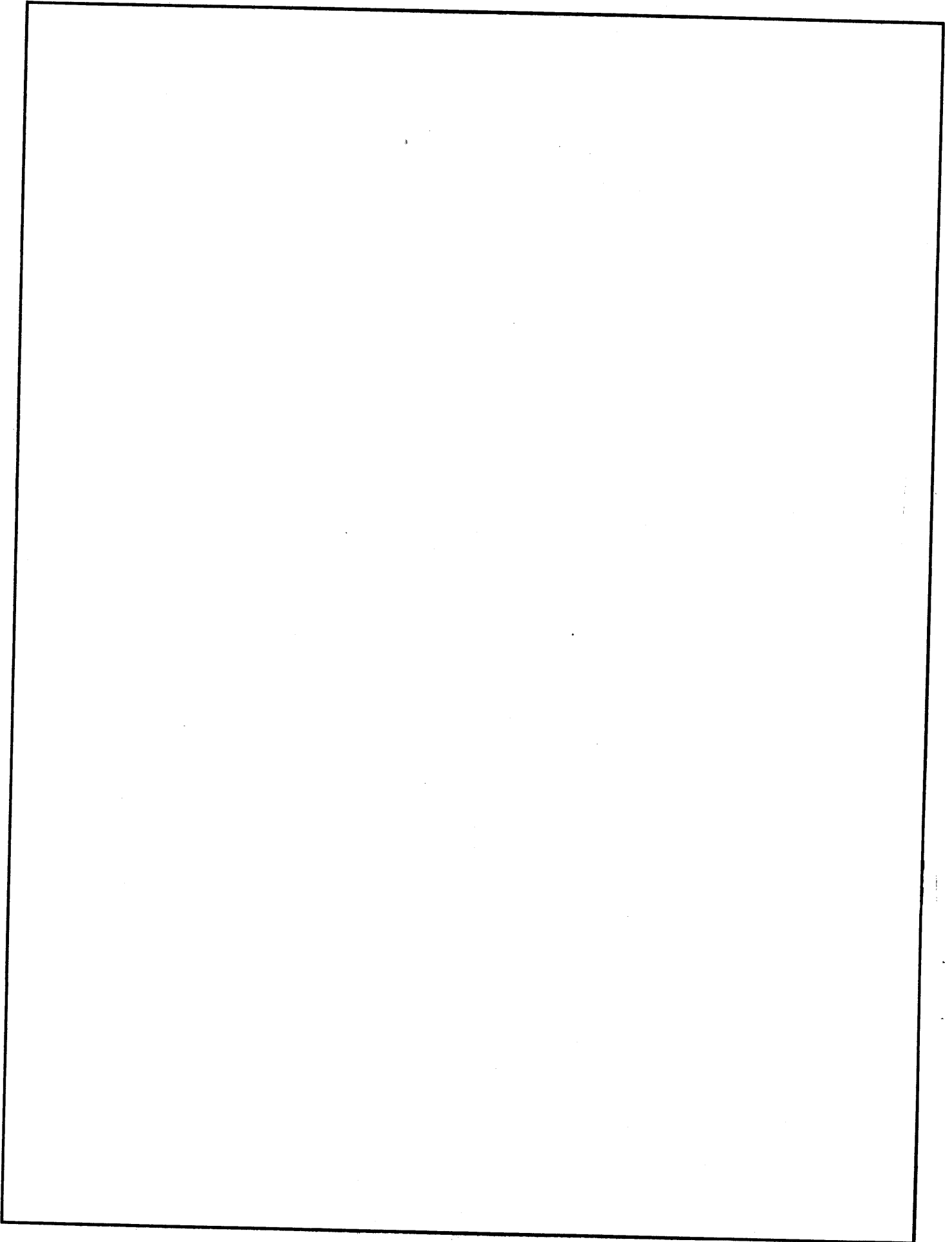

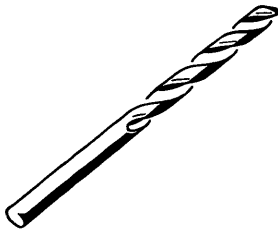

450716 DRILL SET, NO.1 THRU 60 CONSISTING OF

55781	1	.2280	5.79
450300	2	.2210	5.61
450272	3	.2130	5.41
450298	4	.2090	5.30
4001	5	.2055	5.22
450168	6	.2040	5.18
450277	7	.2010	5.10
4000	8	.1990	5.05
450167	9	.1960	4.98
3999	10	.1935	4.91
450301	11	.1910	4.85
3998	12	.1890	4.80
3997	13	.1850	4.70
450278	14	.1820	4.62
55771	15	.1800	4.57
450166	16	.1770	4.50
450130	17	.1730	4.39
450165	18	.1695	4.31
3996	19	.1660	4.22
55770	20	.1610	4.09
450164	21	.1590	4.04
450265	22	.1570	3.99
55769	23	.1540	3.91
450287	24	.1520	3.86
450289	25	.1495	3.80
3995	26	.1470	3.73
3994	27	.1440	3.66
55767	28	.1405	3.57
450163	29	.1360	3.45
450290	30	.1285	3.26
3992	31	.1200	3.05
3991	32	.1160	2.95
55766	33	.1130	2.87
450302	34	.1110	2.82
3990	35	.1100	2.79
3989	36	.1065	2.71
450162	37	.1040	2.64
450179	38	.1015	2.58
450291	39	.0995	2.53
55764	40	.0980	2.49
450263	41	.0960	2.44
450161	42	.0935	2.37
3988	43	.0890	2.26
55763	44	.0860	2.18
3987	45	.0820	2.08
450256	46	.0810	2.06
450160	47	.0785	1.99
55762	48	.0760	1.93
450159	49	.0730	1.85
450257	50	.0700	1.78
3986	51	.0670	1.70
450279	52	.0635	1.61
450262	53	.0595	1.51
450258	54	.0550	1.40
450259	55	.0520	1.32
450037	56	.0465	1.18

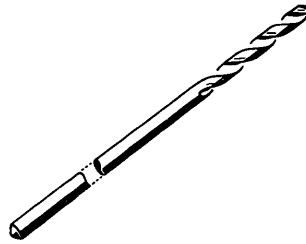

DRILL, EXTENSION	SHANK LENGTH
154292	1/2 IN. 12,72 MM, 24 IN.
450152	1/4 IN. 6,35 MM, 16 IN.
450048	7/32 IN. 5,55 MM, 14 IN.
178666	NO. 7 18 IN.
158799	NO. 16 9 IN.
450047	NO. 19 14 IN.
171308	NO. 20 15 IN.
154365	NO. 21 15 IN.
450236	NO. 28 14 IN.
173260	NO. 29 14 IN.

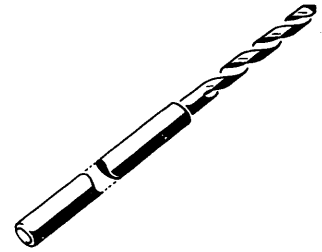

DRILL, EXTENSION	SHANK LENGTH
173262	NO. 14 14 IN.
173261	NO. 24 14 IN.
450237	1/8 IN. 3,18 MM 14 IN.
450002	NO. 33 14 IN.
450058	NO. 37 14 IN.
167717	NO. 48 12 IN.
450253	NO. 53 3,5 IN.

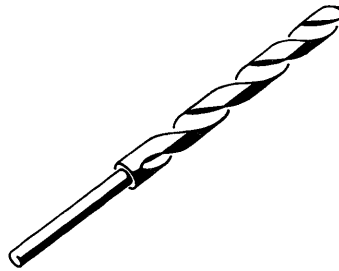

DRILL, SHANK DIA, 1/4 IN.

450369	1/2 IN. 12,70 MM,
450371	3/8 IN. 9,53 MM,
450055	11/32 IN. 8,75 MM,
450421	Q.332 IN. 8,45 MM,
450337	5/16 IN. 7,95 MM,

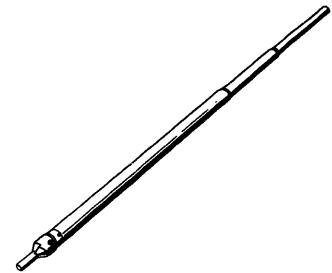

454302 COUNTERSINK, 82 DEG, .311 PILOT, 1/4 SHANK

450299	57	.0430	1.09
450303	58	.0420	1.07
450280	59	.0410	1.04
450264	60	.0400	1.02
3993	1/8	.1250	3.18
4002	D	.2460	6.25
4003	1/4	.2500	6.35
4004	5/16	.3125	7.94
4005	3/8	.3750	9.53
55773	17/64	.2656	6.75
55782	G	.2610	6.63
450169	15/64	.2344	5.95
450170	F.	.2570	6.53



TAP THREADING

	INCH		EXT	MM
158220	8-32	UNC	12 IN.	4,17
450011	10-32	UNF	10 IN.	4,83
178667	1/4-20	UNC	18 IN.	6,35

TAP THREADING

	INCH		MM
55746	2-56	UNC	2,18
55747	3-48	UNC	2,51
4006	4-36	UNS	2,84
55748	4-40	UNC	2,84
4007	5-40	UNC	3,17
4008	6-32	UNC	3,51
55750	6-40	UNF	3,51
4009	8-32	UNC	4,17
55753	8-40	UNS	4,17
55754	10-24	UNC	4,83
55755	10-30	UNS	4,83
4010	10-32	UNF	4,83
55757	12-24	UNC	5,49
450171	14-24	UNS	6,15
450172	1/4-20	UNC	6,35
55759	1/4-24	UNS	6,35
450273	1/4-28	UNF	6,35
55761	5/16-18	UNC	7,94
55760	5/16-24	UNF	7,94
450288	5/16-32	UNS	7,94
450336	3/8-16	UNC	9,53
450422	3/8-24	UNF	9,53

UNC = Coarse Thread
 UNF = Fine Thread
 UNS = Special Thread

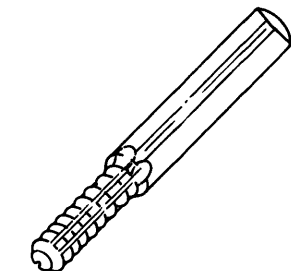

616185 TAP BOTTOMING 6-32

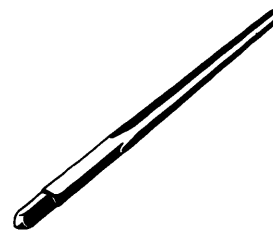
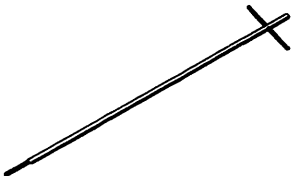

REAMER, TAPER

8955	NO. 0
8956	NO. 1
8957	NO. 2
8958	NO. 3
450270	NO. 4
450269	NO. 5
55797	NO. 2/0
450134	NO. 3/0
55798	NO. 4/0
55799	NO. 5/0
55800	NO. 6/0
450017	NO. 7/0

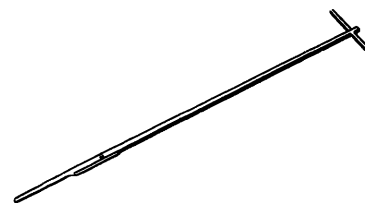

REAMER, HAND, T-BAR, TAPER, EXT.

450008	NO. 0	12 IN.
158644	NO. 1	7 IN.
173257	NO. 1	14 IN.
173258	NO. 2	14 IN.
171307	NO. 2	15 IN.
173259	NO. 3	14 IN.
157919	NO. 4	12 IN.
450295	NO. 4	18 IN.
157920	NO. 5	12 IN.
450296	NO. 5	18 IN.
450001	NO. 2-0	12 IN.
450057	NO. 3-0	12 IN.
167718	NO. 5-0	12 IN.

REAMER, HAND, T-BAR, STRAIGHT, EXT

450375	.061	4 IN.
450294	.156	4 IN.
158759	.187	9 IN.

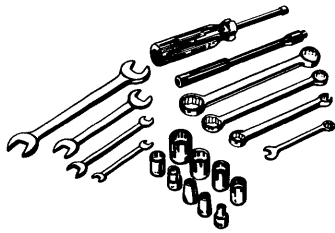

- 152759 WRENCH SET ASSEMBLY, SOCKET AND END CONSISTING OF
- 153690 WRENCH, OPEN END, FIXED 7/32 X 3/16 IN.
- 153691 WRENCH, OPEN END, FIXED 1/4 X 5/16 IN.
- 153692 WRENCH, OPEN END, FIXED 3/8 X 7/16 IN.
- 153693 WRENCH, OPEN END, FIXED 1/2 X 9/16 IN.
- 153701 SOCKET WRENCH, 3/16 IN. 6 PT, 1/4 DR
- 153702 SOCKET WRENCH, 7/32 IN. 6 PT, 1/4 DR
- 153703 SOCKET WRENCH, 1/4 IN. 6 PT, 1/4 DR
- 153704 SOCKET WRENCH, 5/16 IN. 12 PT, 1/4 DR
- 153705 SOCKET WRENCH, 3/8 IN. 12 PT, 1/4 DR
- 153706 SOCKET WRENCH, 1/2 IN. 12 PT, 1/4 DR
- 158765 HANDLE, SOCKET WRENCH, SWIVEL, 1/4 IN. DR
- 158766 SOCKET WRENCH, 7/16 IN. 12 PT, 1/4 DR
- 173993 WRENCH, BOX, TUBE FITTING, 5/16 X 3/8 IN.

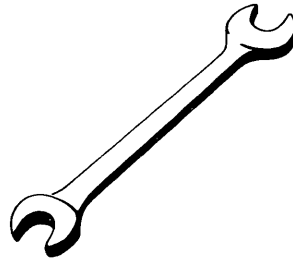

- WRENCH, OPEN END, FIXED
- 9900111 1/8 X 5/32 IN.
 - 9900006 3/16 X 7/32 X 2 3/2 IN.
 - 9900208 3/16 X 7/32 X 3 IN.
 - 153690 7/32 X 3/16 X 2 1/2 IN.
 - 153691 1/4 X 5/16 X 3 IN.
 - 9900005 1/4 X 5/16 X 4 IN.
 - 454329 11/32 X 5/16 IN.
 - 153692 3/8 X 7/16 IN.
 - 153693 1/2 X 9/16 IN.
 - 9900090 5/8 X 3/4 IN.
 - 2244061 9/32 X 11/16 IN.

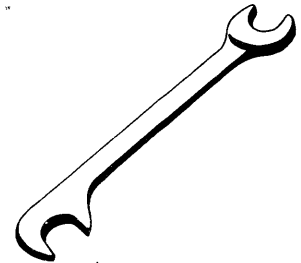

- WRENCH, OPEN END, FIXED
- 460307 3/16 X 3/16 IN.
 - 460308 7/32 X 7/32 IN.
 - 460304 1/4 X 1/4 IN.
 - 460305 5/16 X 5/16 IN.
 - 460309 11/32 X 11/32 IN.
 - 460306 3/8 X 3/8 IN.
 - 605902 1/4 X 1/4 IN. 7 IN. LONG

- 173994 WRENCH, BOX 1/2 X 7/16 IN.
- 173995 WRENCH BOX, 5/8 X 9/16 IN.
- 450069 HANDLE, SOCKET WRENCH 1/4 IN. DR
- 450429 SOCKET WRENCH, 9/16 IN. 12 PT, 1/4 DR
- 450889 WRENCH, BOX AND OPEN END, COMB, 1/4 IN. X 1/4 IN.
- 450979 SOCKET WRENCH, 11/32 IN. 12 PT, 1/4 DR
- 454329 WRENCH, OPEN END, FIXED 11/32 X 5/16 IN.

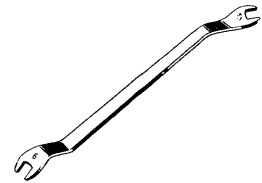

*489857 WRENCH, OPEN END, 5,5 X 6 MM

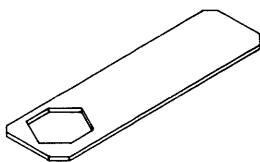

2200194 WRENCH, 1.50 IN 2301, 7303

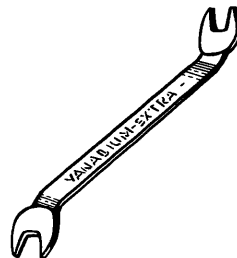

*4261090 WRENCH, OPEN END 7/32 X 3/16 IN.

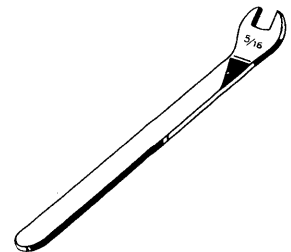

*489878 WRENCH, OPEN END, 5/16 IN., OFFSET

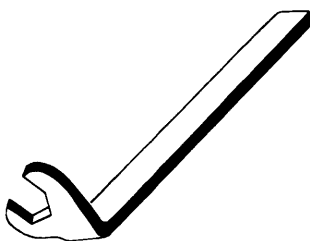

460311 WRENCH, OPEN END, 1/4 IN. OFFSET

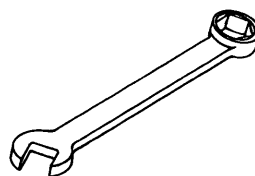

- WRENCH, BOX AND OPEN END, COMB
- 450889 1/4 IN.
 - 460464 5/16 IN.
 - 461617 1/4 IN. 12 POINT

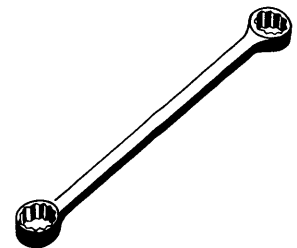

- WRENCH, BOX
- 173994 1/2 X 7/16 IN.
 - 173995 5/8 X 9/16 IN.

Group 3

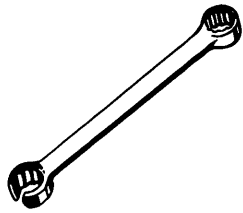

173993 WRENCH, BOX, TUBE FITTING,
5/16 X 3/8 IN.

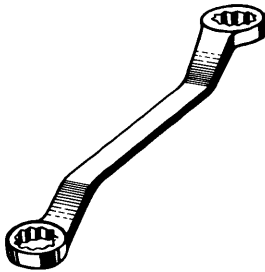

856481 WRENCH, BOX,
11/16 X 3/4 IN.

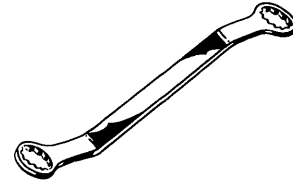

*489841 9 X 9,5 MM, OFFSET
*489840 10 X 11 MM, OFFSET

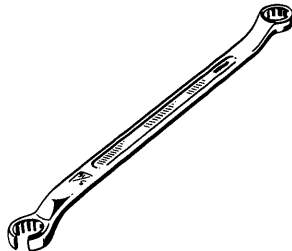

*489902 WRENCH, BOX,
1/4 X 5/16 IN.

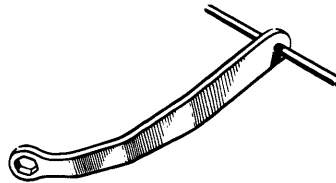

*489239 WRENCH, BOX, 8 MM,
T-HANDLE



605903 WRENCH, 1/4 IN.,
OFFSET, T-HANDLE

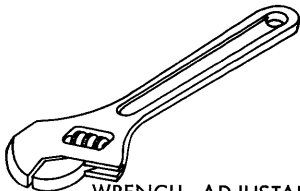

WRENCH, ADJUSTABLE
4045 6 IN.
454353 8 IN.
450177 10 IN.
2200031 12 IN.

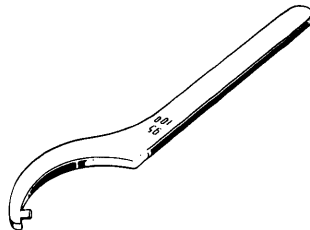

221244 WRENCH, SPANNER, 11/32 IN.
AUTO CARRIAGE

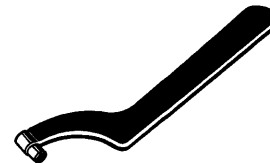

450128 WRENCH, SPANNER, 4 IN.

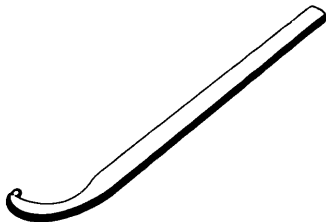

461129 WRENCH, SPANNER

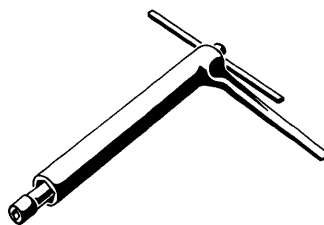

461128 WRENCH ASM, OUTER-INNER
T-BAR 7600

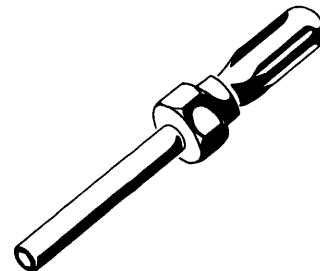

454350 WRENCH, DRUM HEAD
ADJUSTING

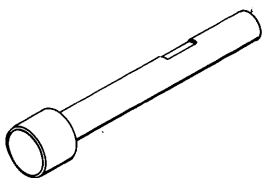





637038 COUNTERBORE, PILOT

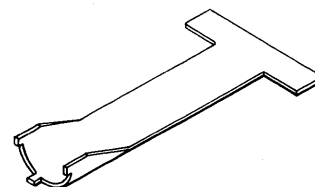

2108001 WRENCH, SPANNER,
SPIDER LOCKNUT

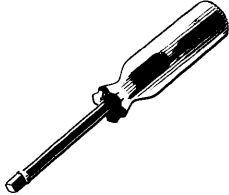

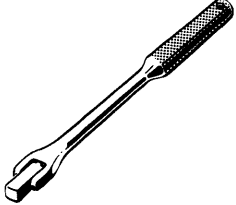
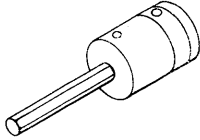
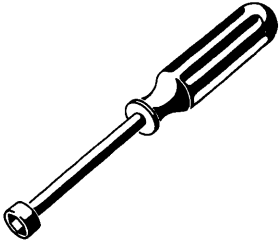
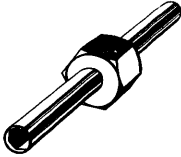
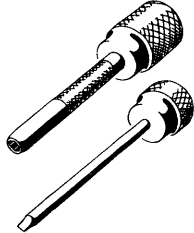
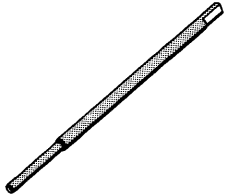
460892 WRENCH, SPANNER,
T-HANDLE

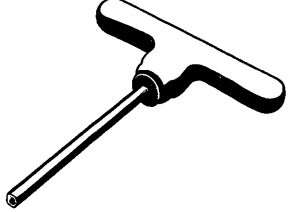
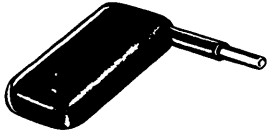
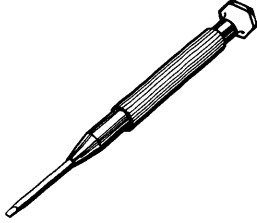
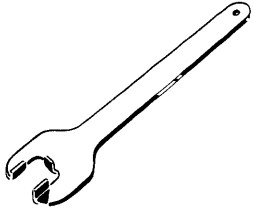
 <p>450069 HANDLE, SOCKET WRENCH, 1/4 IN. DR.</p>		 <p>2108040 ADAPTER, SOCKET WRENCH 3/8 SQ DR, 5/16 HEX 7030589 ADAPTER SOCKET 3/8 DR 1/4 HEX</p>																																				
 <p>158765 HANDLE, SOCKET WRENCH, SWIVEL, 1/4 IN. DR.</p>	<p>SOCKET WRENCH</p> <table border="0"> <tr><td>153701</td><td>3/16 IN.</td><td>6 PT,</td><td>1/4 DR</td></tr> <tr><td>153702</td><td>7/32 IN.</td><td>6 PT,</td><td>1/4 DR</td></tr> <tr><td>153703</td><td>1/4 IN.</td><td>6 PT,</td><td>1/4 DR</td></tr> <tr><td>153704</td><td>5/16 IN.</td><td>12 PT,</td><td>1/4 DR</td></tr> <tr><td>153705</td><td>3/8 IN.</td><td>12 PT,</td><td>1/4 DR</td></tr> <tr><td>158766</td><td>7/16 IN.</td><td>12 PT,</td><td>1/4 DR</td></tr> <tr><td>153706</td><td>1/2 IN.</td><td>12 PT,</td><td>1/4 DR</td></tr> <tr><td>450429</td><td>9/16 IN.</td><td>12 PT,</td><td>1/4 DR</td></tr> <tr><td>450979</td><td>11/32 IN.</td><td>12 PT,</td><td>1/4 DR</td></tr> </table>	153701	3/16 IN.	6 PT,	1/4 DR	153702	7/32 IN.	6 PT,	1/4 DR	153703	1/4 IN.	6 PT,	1/4 DR	153704	5/16 IN.	12 PT,	1/4 DR	153705	3/8 IN.	12 PT,	1/4 DR	158766	7/16 IN.	12 PT,	1/4 DR	153706	1/2 IN.	12 PT,	1/4 DR	450429	9/16 IN.	12 PT,	1/4 DR	450979	11/32 IN.	12 PT,	1/4 DR	 <p>2108914 ADAPTER, DRIVE SOCKET, 2.06 IN. LONG 3/8" SQ. DRIVE</p>
153701	3/16 IN.	6 PT,	1/4 DR																																			
153702	7/32 IN.	6 PT,	1/4 DR																																			
153703	1/4 IN.	6 PT,	1/4 DR																																			
153704	5/16 IN.	12 PT,	1/4 DR																																			
153705	3/8 IN.	12 PT,	1/4 DR																																			
158766	7/16 IN.	12 PT,	1/4 DR																																			
153706	1/2 IN.	12 PT,	1/4 DR																																			
450429	9/16 IN.	12 PT,	1/4 DR																																			
450979	11/32 IN.	12 PT,	1/4 DR																																			
 <p>9900061 SPINTITE 5/16 IN.</p>	 <p>21213 WRENCH, SOCKET, .190 AND .221 IN. KEY PUNCH</p>	 <p>* 489174 SOCKET WRENCH WITH SCREWDRIVER, KEY PUNCH</p>																																				
 <p>450831 WRENCH, SOCKET, 16 X 7- 1/2 IN., CONTROL TAPE</p>	 <p>451913 HEX WRENCH ADAPTER 3/16</p>	 <p>460947 3/16 IN. 461275 .188 IN.</p> <p>KEY, SOCKET HD SCR, TEE HANDLE</p>																																				
 <p>461137 KEY, HEX, .12 IN DIA., TOWER LATCH</p>	 <p>* 802171 ALLEN SCREWDRIVER, HEX 1,27 MM</p>	 <p>453607 WRENCH, LEVELING PAD</p>																																				

Group 3

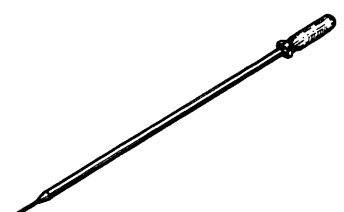

SCREWDRIVER, EXTENSION
 450721 NO. 10, 6 FLUTE, 12 IN.
 450722 NO. 5, 4 FLUTE, 12 IN.

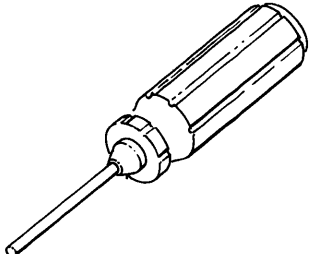

460812 SCREWDRIVER, 6 FLUTE,
 .110 DIA.

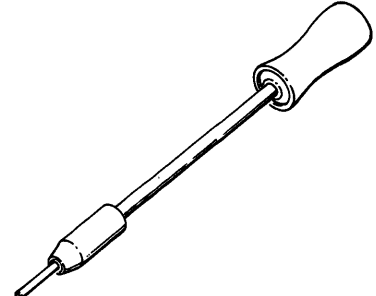

*489929 HOLDER, SOCKET KEY

SOCKET KEY, HEX

DIMENSIONS, INCH			PART NUMBER	DIMENSIONS, MM		
A	B	C		A	B	C
.028	X .3	X 1.2	2108315	.71	X 7.6	X 30
.035	X .3	X 1.2	452220	.89	X 7.6	X 30
.050	X .6	X 2.9	74925	1.27	X 15.2	X 74
.050	X .6	X 4.0	9900062	1.27	X 15.2	X 102
.050	X 1.7	X 4.9	460314	1.27	X 43.2	X 124
.062	X .6	X 3.1	77009	1.57	X 15.2	X 79
.062	X 1.7	X 4.9	460313	1.57	X 43.2	X 124
.077	X .7	X 3.3	450372	1.96	X 17.8	X 84
.077	X 1.7	X 4.9	460312	1.96	X 43.2	X 124
.093	X .8	X 3.6	450373	2.36	X 20.3	X 91
.108	X .8	X 2.2	2108490	2.74	X 20.3	X 56
.125	X .9	X 3.9	116574	3.18	X 22.9	X 99
.140	X 1.0	X 2.5	451553	3.56	X 25.4	X 64
.155	X 1.0	X 4.4	7231	3.94	X 25.4	X 112
.187	X 1.1	X 2.9	178397	4.75	X 27.9	X 74
.218	X 1.2	X 3.2	450038	5.54	X 30.5	X 81
.250	X 1.3	X 3.5	450453	6.35	X 33.0	X 89
.312	X 1.5	X 4.0	450454	7.92	X 38.1	X 102
.375	X 1.3	X 6.7	450455	9.53	X 33.0	X 170
.500	X 2.0	X 8.6	2108467	12.70	X 50.8	X 218

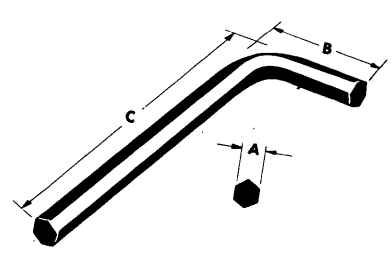

SOCKET KEY, 6 FLUTE

DIMENSIONS, INCH			PART NUMBER	DIMENSIONS, MM		
A	B	C		A	B	C
.047	X .6	X 4.0	9900216	1.19	X 15.2	X 102
.057	X .5	X 3.0	450814	1.45	X 12.7	X 76
.060	X .4	X 4.0	9900028	1.52	X 10.2	X 102
.070	X .6	X 1.8	2108306	1.78	X 15.2	X 46
.070	X .6	X 3.1	451552	1.78	X 15.2	X 79
.070	X .3	X 3.1	2200051	1.78	X 7.6	X 79
.072	X .6	X 4.0	9900200	1.83	X 15.2	X 102
.094	X .3	X 3.2	2108626	2.39	X 7.6	X 81
.094	X .7	X 3.2	450042	2.39	X 17.8	X 81
.110	X .8	X 3.6	450043	2.79	X 20.3	X 91
.132	X .7	X 3.6	9900255	3.35	X 17.8	X 91
.133	X .9	X 2.3	451551	3.38	X 22.9	X 58
.143	X .9	X 2.4	450050	3.63	X 22.9	X 61
.168	X 1.0	X 4.1	452395	4.27	X 25.4	X 104
.183	X 1.0	X 4.0	9900103	4.65	X 25.4	X 102
.312	X 1.2	X 3.2	9900019	7.92	X 30.5	X 81

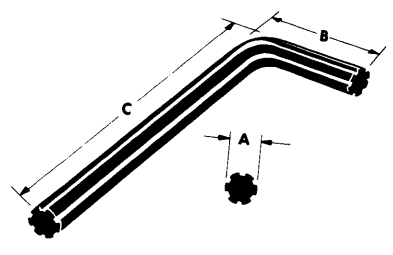

SOCKET KEY, 4 FLUTE

DIMENSIONS, INCH			PART NUMBER	DIMENSIONS, MM		
A	B	C		A	B	C
.047	X .3	X 1.2	2108498	1.19	X 7.6	X 30
.047	X .4	X 3.0	9900173	1.19	X 10.2	X 76
.067	X .5	X 3.4	165584	1.70	X 12.7	X 86
.076	X .6	X 3.1	450815	1.93	X 15.2	X 79
.090	X .5	X 3.2	112646	2.29	X 12.7	X 81
.109	X .6	X 2.0	123789	2.77	X 15.2	X 51
.131	X .7	X 3.7	152857	3.33	X 17.8	X 94

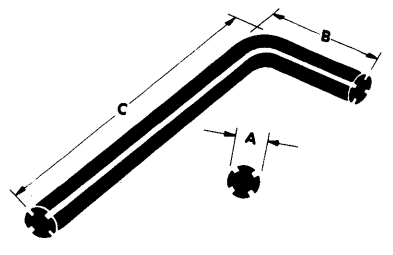

450466 KEY SET, HEX AND FLUTED
CONSISTING OF:

450467 CASE, CANVAS
SOCKET KEY, HEX

DIMENSIONS, INCH			PART NUMBER	DIMENSIONS, MM		
A	B	C	A	B	C	
.028 X	.3 X	1.2	2108315	.71 X	7.6 X 30	
.050 X	.6 X	2.9	74925	1.27 X	15.2 X 74	
.062 X	.6 X	3.1	77009	1.57 X	15.2 X 79	
.077 X	.7 X	3.3	450372	1.96 X	17.8 X 84	
.093 X	.8 X	3.6	450373	2.36 X	20.3 X 91	
.108 X	.8 X	2.2	2108490	2.74 X	20.3 X 56	
.125 X	.9 X	3.9	116574	3.18 X	22.9 X 99	
.140 X	1.0 X	2.5	451553	3.56 X	25.4 X 64	
.155 X	1.0 X	4.4	7231	3.94 X	25.4 X 112	
.187 X	1.1 X	2.9	178397	4.75 X	27.9 X 74	
.218 X	1.2 X	3.2	450038	5.54 X	30.5 X 81	
.250 X	1.3 X	3.5	450453	6.35 X	33.0 X 89	
.312 X	1.5 X	4.0	450454	7.92 X	38.1 X 102	

SOCKET KEY, 6 FLUTE

.047 X	.6 X	4.0	9900216	1.19 X	15.2 X 102
.057 X	.5 X	3.0	450814	1.45 X	12.7 X 76
.070 X	.6 X	3.1	451552	1.78 X	15.2 X 79
.094 X	.7 X	3.2	450042	2.39 X	17.8 X 81
.110 X	.8 X	3.6	450043	2.79 X	20.3 X 91
.133 X	.9 X	2.3	451551	3.38 X	22.9 X 58
.143 X	.9 X	2.4	450050	3.63 X	22.9 X 61
.168 X	1.0 X	4.1	452395	4.27 X	25.4 X 104

SOCKET KEY, 4 FLUTE

.067 X	.5 X	3.4	165584	1.70 X	12.7 X 86
.076 X	.6 X	3.1	450815	1.93 X	15.2 X 79

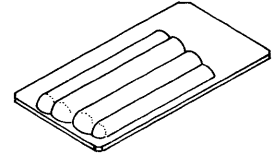
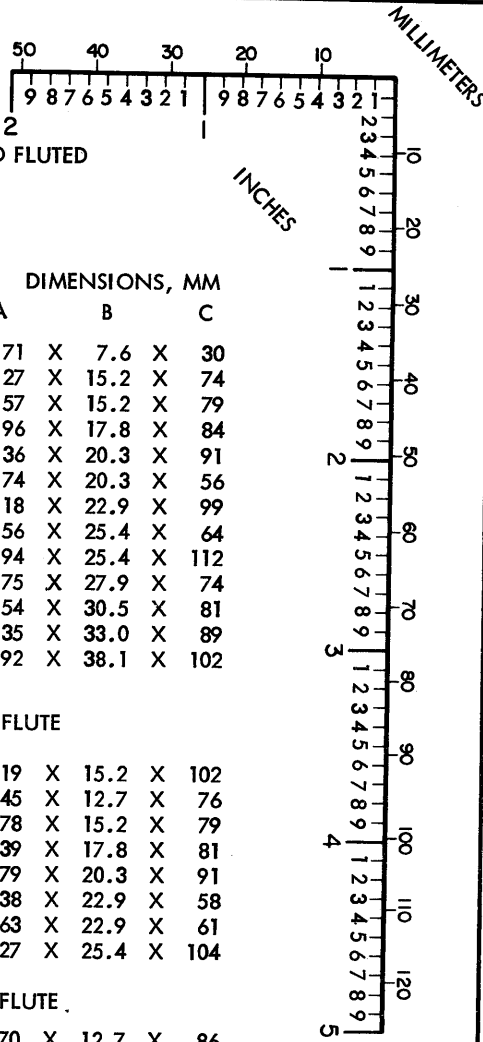

9900027 KIT, KEYWRENCH

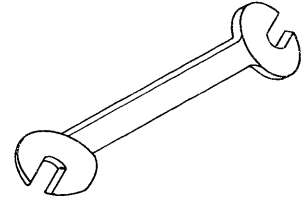

2200464 WRENCH, 30 DEG - 60 DEG
7/16 IN OPEN END
2314 DASF

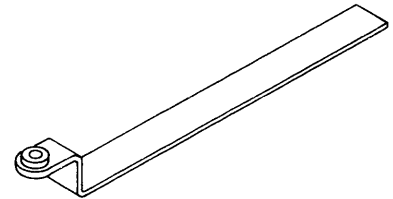

9900100 WRENCH, 1/4 OFFSET

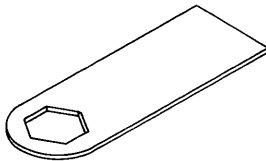

2108767 WRENCH, COMPRESSOR

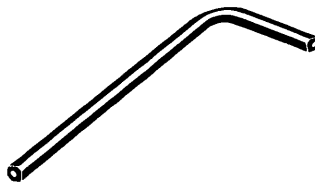

453608 WRENCH, HEX, TAPE HEAD

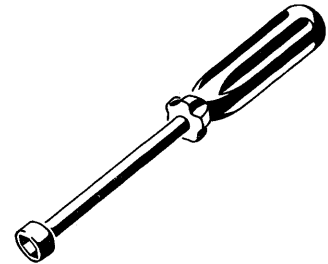

453609 WRENCH, TAPE HEAD ADJ.

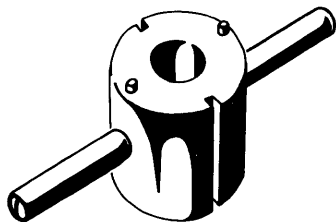

2121394 WRENCH, SPANNER, HYD.
ACTUATOR OUTPUT SEAL

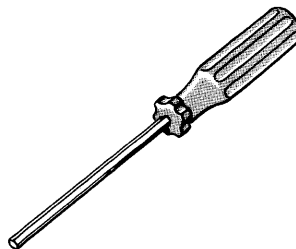

2200104 WRENCH, FRONT
DOOR, 2314

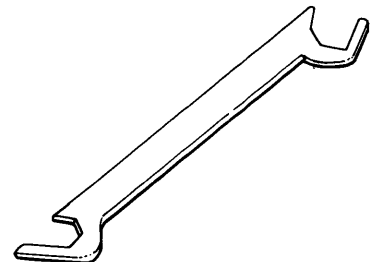

9900226 WRENCH, VELOCITY
PLATE ADJ.

Group 3

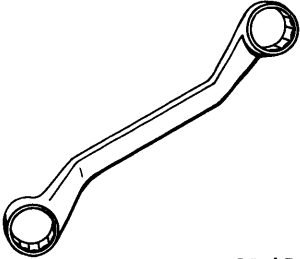
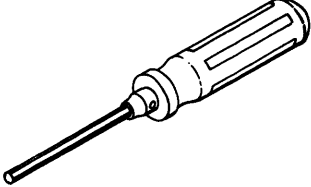
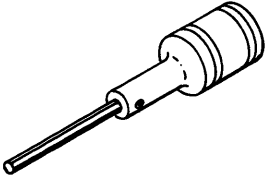
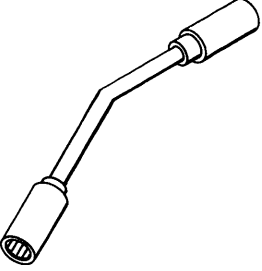
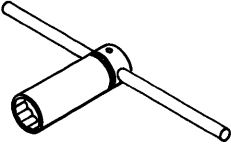
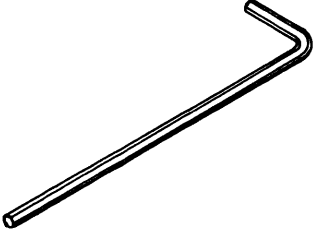
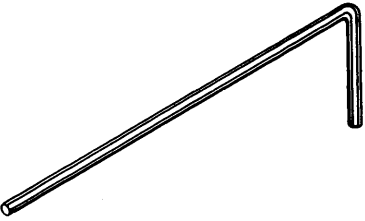
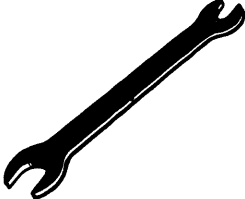
 <p>834327 WRENCH, SELECTOR ADJ LOCKNUT, 9/32 HEX X 1/4 HEX 1419</p>	 <p>2200176 DRIVER, SPLINE, 3-1/2 IN TIP 2301 - 2303</p>	 <p>2200161 HOLDER, 9/64 HEX 1/4" DRIVE 2321</p>
 <p>2515390 WRENCH, CAPSTAN MOTOR 2420</p>	 <p>460290 WRENCH, SOCKET, 7/8 IN DEEP, W/BAR</p>	 <p>2200204 WRENCH, HEX, 9 IN 2321</p>
 <p>2533723 CAPSTAN ADJ TOOL 3420</p>	 <p>WRENCH, OPEN END 450802 1/8 X 3/16 IN., PRINT HD NUT * 489895 1/2 X 3/8 IN. *9007472 9/16 X 5/8 IN.</p>	

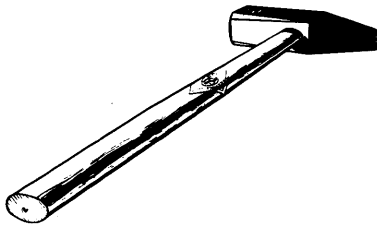

*489036 HAMMER, FLAT PEEN,
5 OZ, 150 GR
*489982 HAMMER, FLAT PEEN,
7 OZ, 200 GR

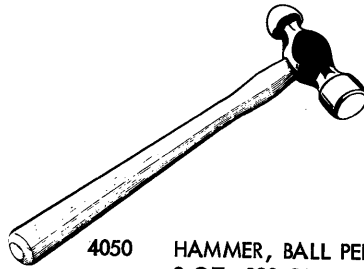

4050 HAMMER, BALL PEEN,
8 OZ, 230 GR
450571 HAMMER, BALL PEEN,
24 OZ, 700 GR



9900190 HAMMER, COMBINATION,
T-BENDER

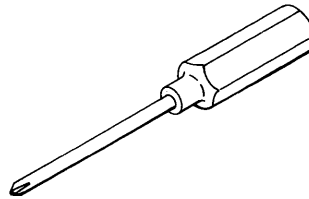

2197195 SCREWDRIVER, NO. 2
PHILLIPS POINT 1134



*489146 SCREWDRIVER

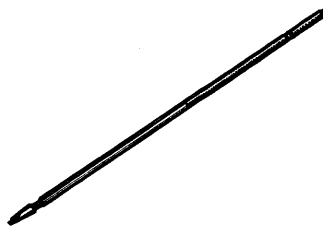

9900328 SCR. STARTER, L.G.
450619 SCREW STARTER,
HAND, 7-64 IN

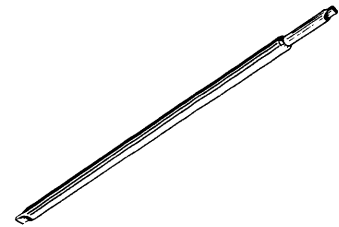

460811 SCREWDRIVER, ALIGNMENT,
FIBER PROBE

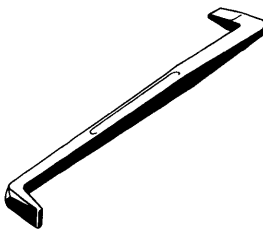

*489136 SCREWDRIVER, OFFSET

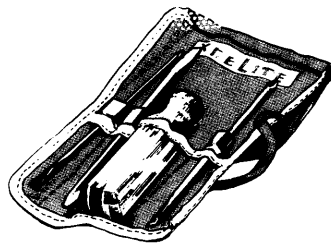

460258 SCREWDRIVER, KIT,
PHILLIPS AND STD.

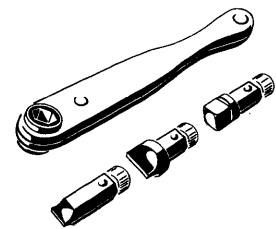

451135 KIT ASM, RATCH
SCREWDRIVER
451134 CASE, PLASTIC

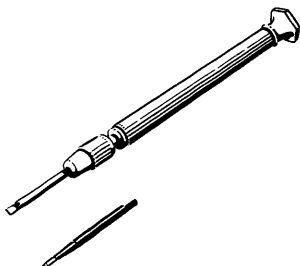

461228 SCREWDRIVER ASM,
HANDLE AND BLADE
461226 BLADE, POT. ADJUSTING

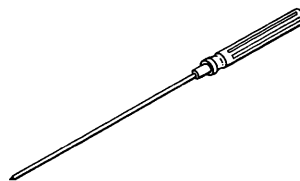

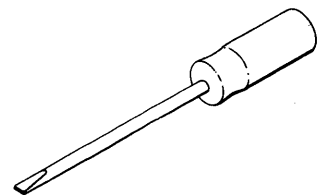

9900212 SCREW STARTER, HAND

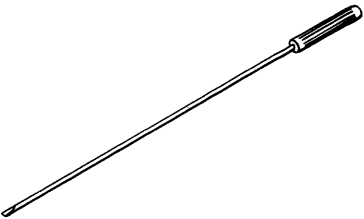
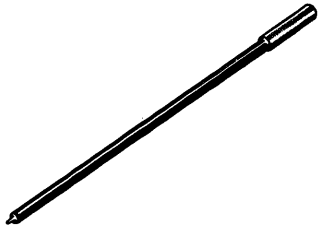

9900068 SCREWDRIVER, 6 IN BLADE,
HEAVY
9900079 SCREWDRIVER, 5 IN BLADE

Group 4

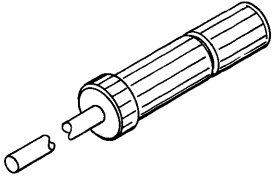
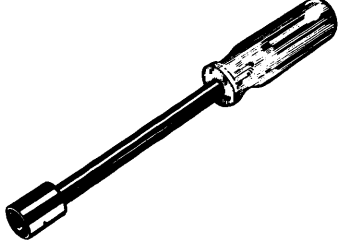
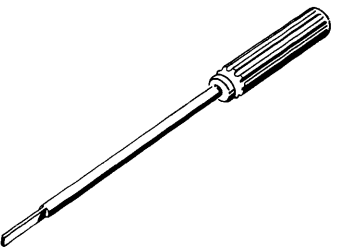
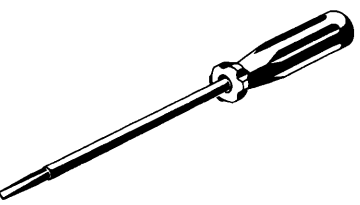
 <p>*4261079 SCREWDRIVER INSERT, HYDRAULIC 1311</p>	 <p>450744 SCREWDRIVER, ADJ 719</p>	 <p>450743 SCREWDRIVER, ADJUSTMENT, SPANNER, 719</p>
 <p>* 8021710 SCREWDRIVER</p>	 <p>2200139 SCREWDRIVER, TRIGGER ADJ</p>	 <p>505289 SCREWDRIVER, CAPTIVE</p>
 <p>2108766 ALIGNMENT TOOL</p>	 <p>153694 SCREWDRIVER, 1/8X4 IN BLADE 153696 SCREWDRIVER, 9/32X8 IN BLADE 153697 SCREWDRIVER, 1/4X10 IN BLADE 178577 SCREWDRIVER, 3/32X4 IN BLADE 450495 SCREWDRIVER, 3/16X6 IN BLADE 450818 SCREWDRIVER, 1/8X8 IN BLADE 153698 SCREWDRIVER, 1/4X1-1/2 IN BLADE</p>	

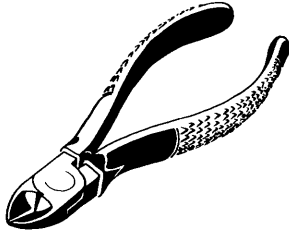

4028 PLIERS, DIAGONAL CUTTING, 5 IN.

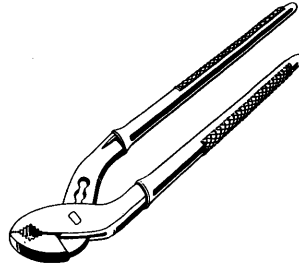

*489905 PLIERS, POLYCRIP



4029 PLIERS, GAS

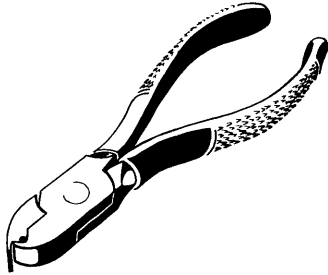

* 490606 PLIERS, CRIMPING TOOL

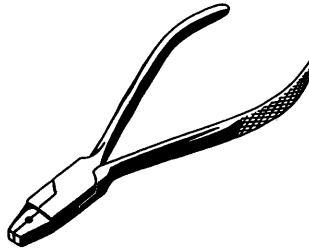

343641 PLIERS, BEAD CLOSING

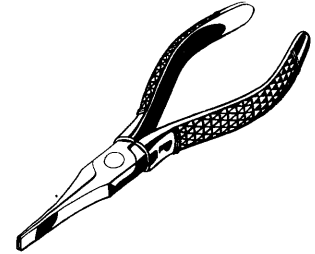

*489017 PLIERS, ADJUSTING

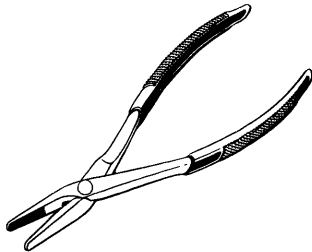

450504 PLIERS, DUCK BILL, 8 IN., INSUL

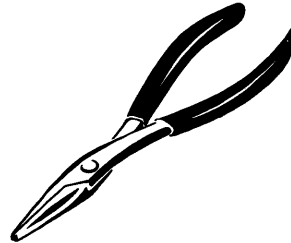

460808 PLIERS, LONGNOSE, 8 IN., INSUL



450494 PLIERS, LONG NOSE, 6 IN., INSUL

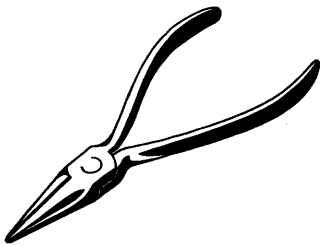

450786 PLIERS, JEWELERS, CHAIN NOSE, 4-1/2 IN.

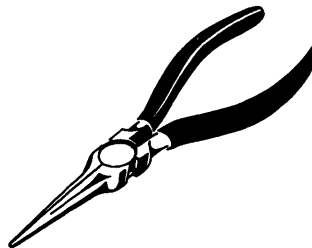

460807 PLIERS, NEEDLE NOSE, 6-1/2 IN., INSUL

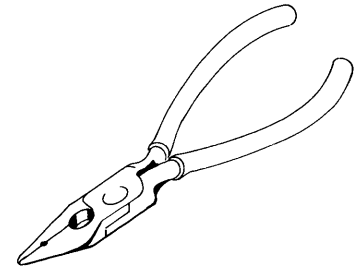

452528 WIRE STRIPPER NO. 30

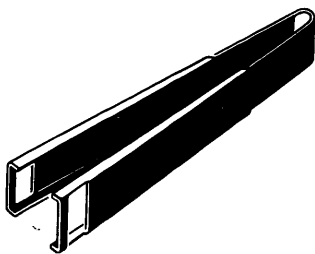

9900373 KEY BUTTON PULLER

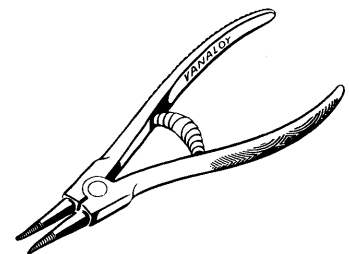

*489967 PLIERS, RETAINING CLIP

Group 5

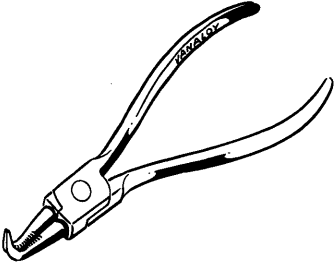
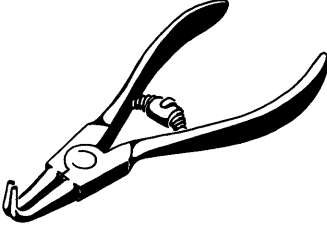
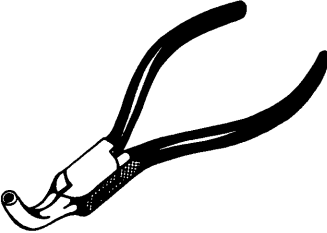
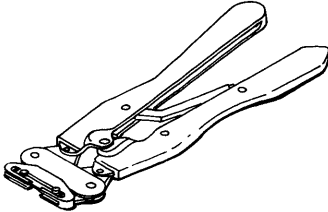
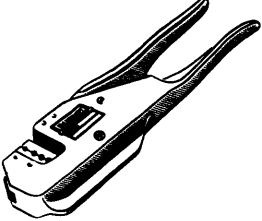
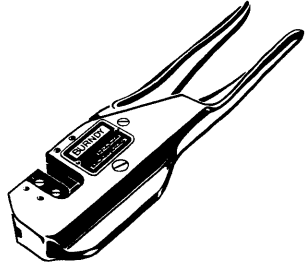
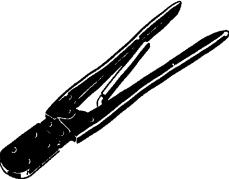
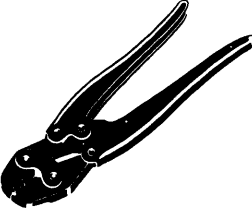
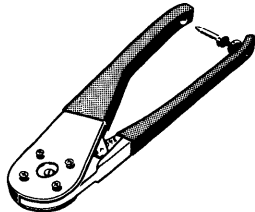
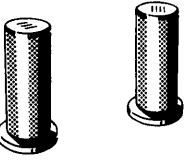
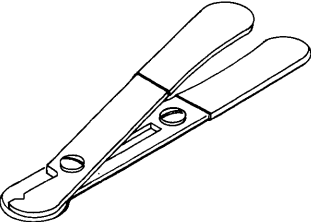
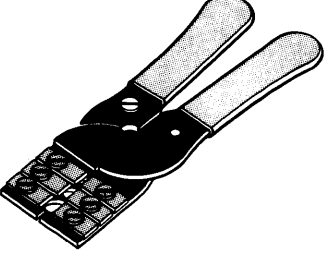
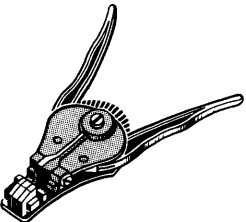
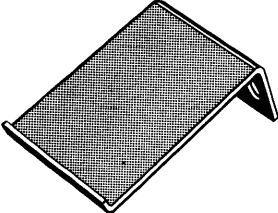
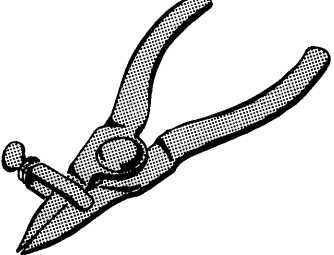
 <p>*489968 PLIERS, RETAINING CLIP</p>	 <p>*489969 PLIERS, RETAINING CLIP</p>	 <p>2108305 PLIERS, PLASTIC TUBE</p>
 <p>453575 CRIMPING TOOL 2948-4</p>	 <p>460294 CRIMPING TOOL, BURNDY MR 8-1A</p>	 <p>461071 CRIMPING TOOL, BURNDY MR8EC-16</p>
 <p>461070 CRIMPING TOOL, AMP. 59501</p>	 <p>450898 CRIMPING TOOL, AMP. 46493-3</p>	 <p>461059 CRIMPING TOOL, WINCHESTER 107-09032</p>
 <p>461058 LOCATOR, FIXED FOR CRIMPING TOOL, 461059</p>	 <p>450694 STRIPPER, WIRE</p>	 <p>5230092 STRIPPER, COAXIAL CABLE</p>
 <p>461075 STRIPPER, WIRE 16-26</p>	 <p>461076 STOP, WIRE STRIPPER, FOR 461075</p>	 <p>460966 PLIERS, TETAINING RING, ST. TIPS, EXT.</p>

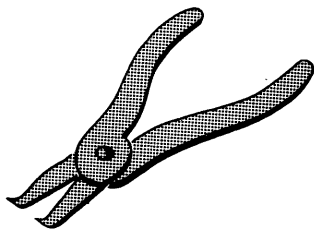

460622 PLIERS, TETAINING RING,
BENT TIPS, INT.

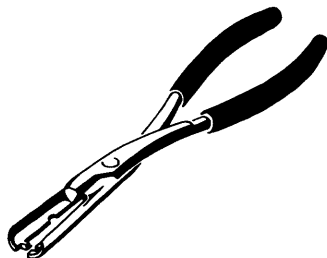

461158 PLIERS, CLIP INSERTING,
INSULATED



9504490 S-TYPEBAR BENDER
9900096 S-TYPEBAR BENDER

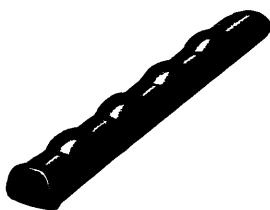

454312 INSULATOR, PLIERS HANDLE,
PLASTIC, PAIR

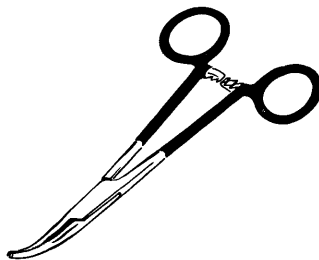

452368 CLAMP SCISSOR
9900233 CLAMP SCISSOR
STRAIGHT TIP

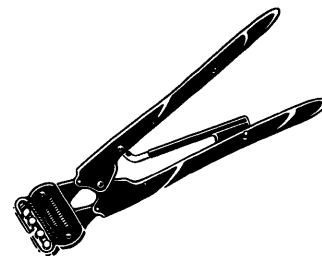

453510 CRIMPING TOOL
AMP 45639

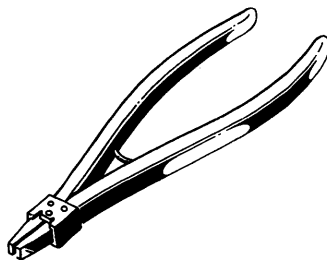

2200101 PLIERS, 2314 GRIP RING

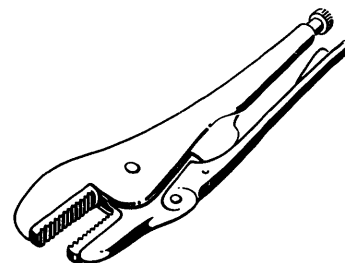

453198 PLIERS, VISE GRIP

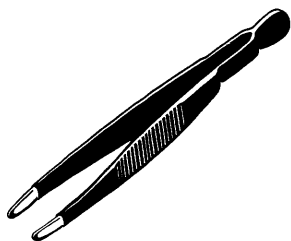

*489193 TWEEZERS JEWELER,
INSULATED
605904 TWEEZERS, JEWELER

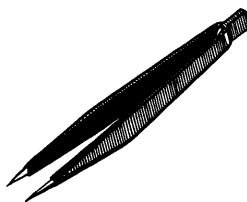

* 4261107 TWEEZERS, POINTED,
INSULATED

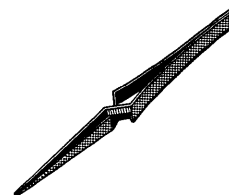

2108014 TWEEZERS, SELF-CLOSING

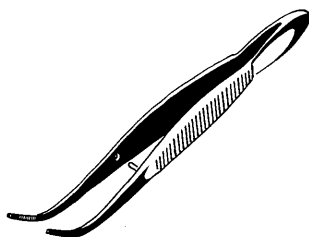

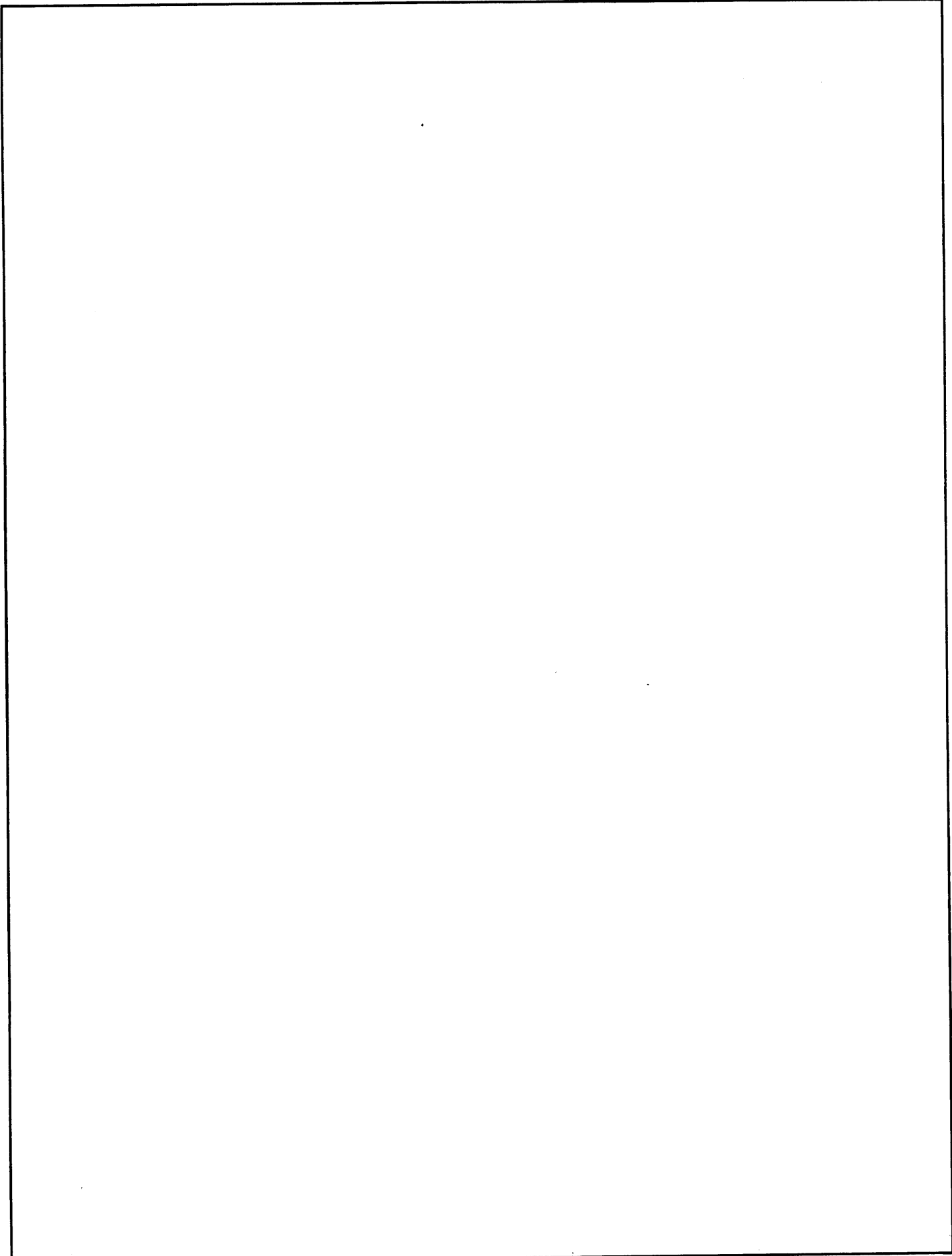

*489242 TWEEZERS, BENT TIP

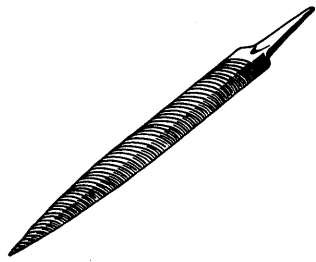
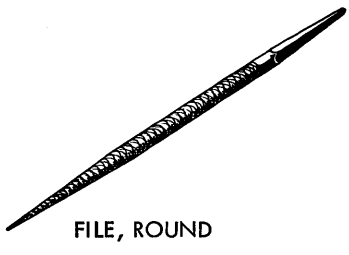
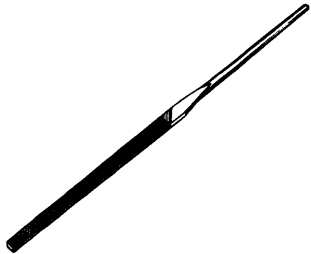
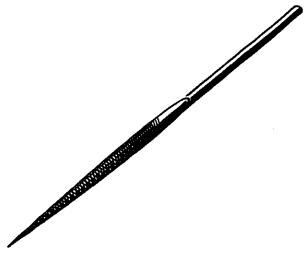
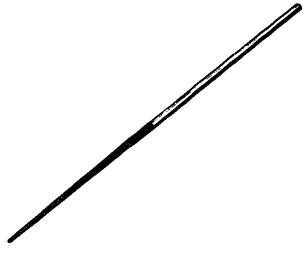
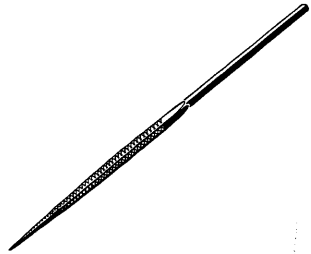
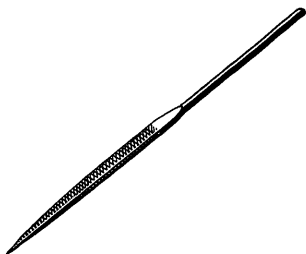
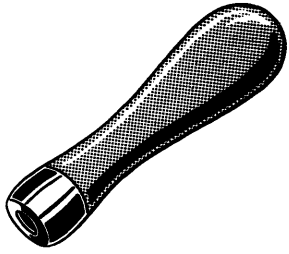
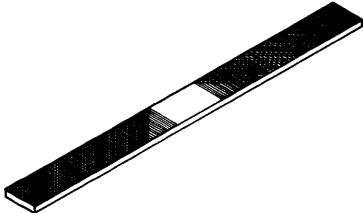
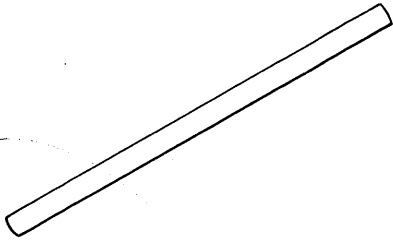
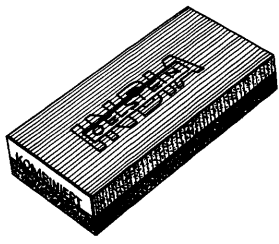
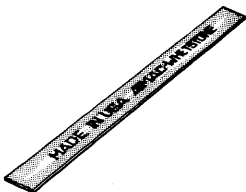
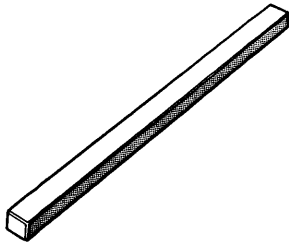
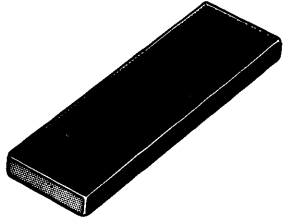

	 <p>FILE, HALF ROUND 4013 6 IN, MEDIUM</p>	 <p>FILE, ROUND 4014 6 IN, MEDIUM *4351130 6 IN, ROUGH *4351049 4 IN, MEDIUM</p>
 <p>*4351136 FILE, HAND, 8 IN, MILL</p>	 <p>*4351137 FILE, HAND, 6 IN, HALF ROUND</p>	 <p>*4351138 FILE, HAND, 6 IN, ROUND</p>
 <p>*4351140 FILE, HAND, 6 IN, TRIANGLE</p>	 <p>*4351141 FILE, HAND, 6 IN, KNIFE</p>	 <p>18975 HANDLE, FILE</p>
 <p>*489076 FILE, RELAY CONTACT</p>	 <p>450567 BLADE, BURNISHING, SILVER CONTACT</p>	 <p>18463 STONE, SHARPENING</p>
 <p>165866 STICK, ABRASIVE</p>	 <p>450426 STONE, BRUSH SEATING</p>	 <p>450503 STICK, EMERY POLISHING</p>

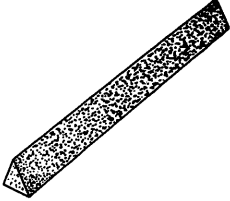
Group 6

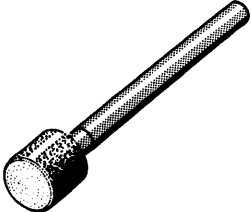
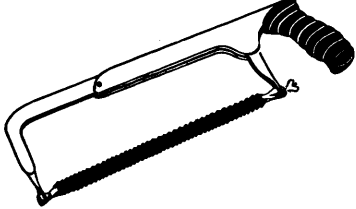
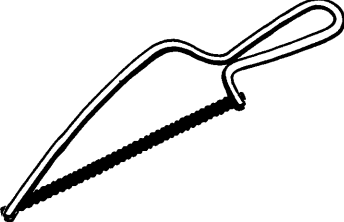
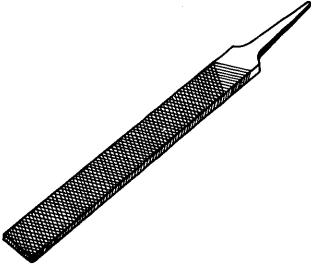
 <p>*4690840 OIL STONE</p>	 <p>450468 WHEEL ABRASIVE 80 GRIT, 3/4 X 6 IN. OD</p>	 <p>450483 WHEEL, ABRASIVE, 80 GRIT, 3/22 X 6 IN. OD</p>
 <p>WHEEL, ABRASIVE, SHANK 450551 1 X 1-1/2 IN., 1 IN. 450552 1/2 X 1/1 IN., 1/4 IN. 450553 1 X 1/2 IN., 1/4 IN.</p>	<p>ABRASIVE LINEN</p> <p>158955 ABRASIVE PAPER 150A COARSE 450319 ABRASIVE CROCUS CLOTH POLISH 460107 ABRASIVE FINE PAPER, 600A</p>	 <p>450155 FRAME, HAND HACKSAW 450156 BLADE, HAND HACKSAW 24 T, 10 IN. 450157 BLADE, HAND HACKSAW, 32 T, 10 IN.</p>
 <p>450432 FRAME, HAND, HACKSAW 450433 BLADE, HAND HACKSAW, 32 T, 6 IN.</p>	 <p>FILE, MILL 4011 6 IN., MEDIUM *4531166 6 IN., ROUGH 18974 6 IN., PILLAR, MEDIUM</p>	

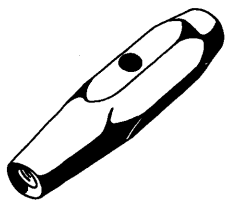

450054 PULLER, DOWEL PIN,
10-32 X 5-40

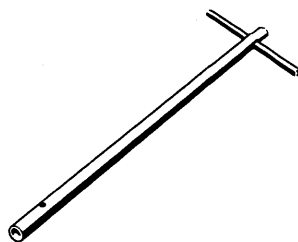

450554 PULLER, DOWEL, PIN
T-BAR 1/4-20 NC

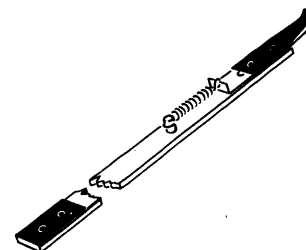

450108 PULLER AND INSERTER,
HORSESHOE CLIP

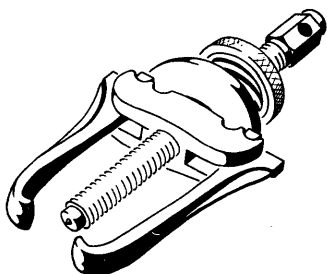

450365 PULLER, GEAR AND WHEEL

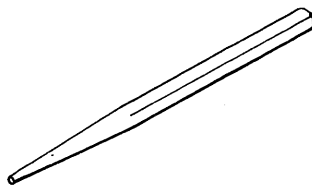

650013 PUNCH, DRIVE PIN,
.75 X 41 IN
1978459 PUNCH, ROLL PIN

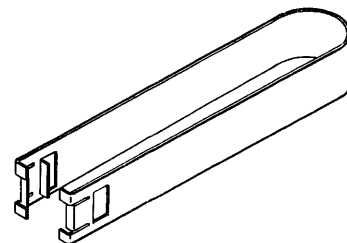

454065 PULLER, RELAY

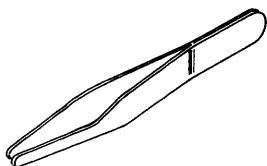

2200045 TOOL, STRIP REMOVAL

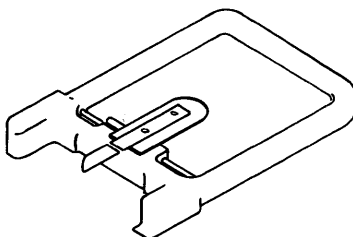

451030 PULLER, SMS CARD,
SINGLE

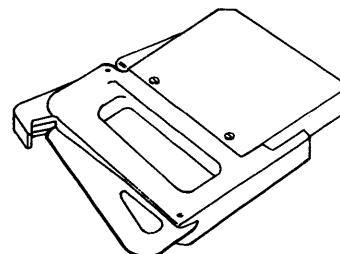

461110 PULLER, SMS CARD, DOUBLE

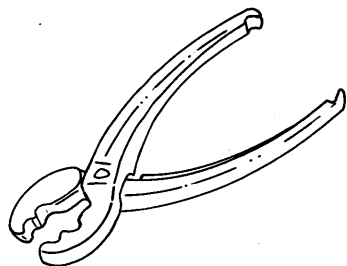

452397 REED RELAY PULLER
AND FUSE PULLER

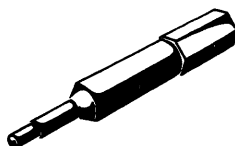

EXTRACTOR, TERM

- 461044 BURNDY RX 4-1
- 461043 BURNDY RX 20-10
- 461046 BURNDY RX 12-6
- 461072 BURNDY RX 16-5
- 461073 BURNDY RX 20-18
- 461060 WINCHESTER

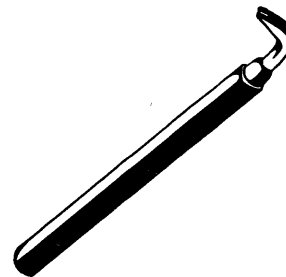

461074 EXTRACTOR, LAMINAR BUSS
TAPER TAB

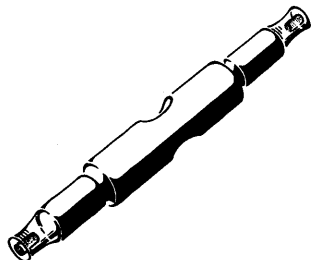

461061 BULB EXTRACTOR

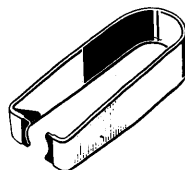



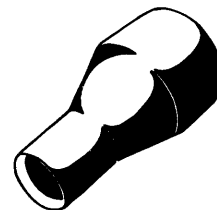

461420 LAMP EXTRACTOR

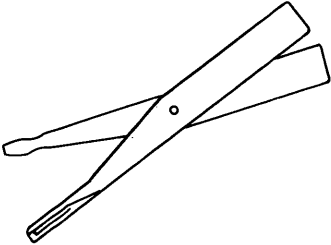
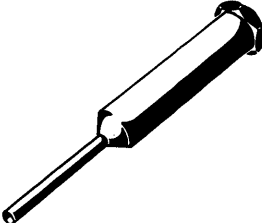
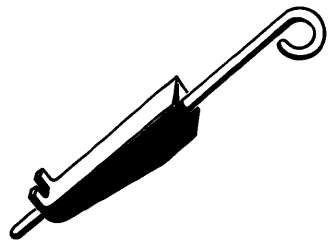

460820 EXTRACTOR, ELECTRON
TUBE

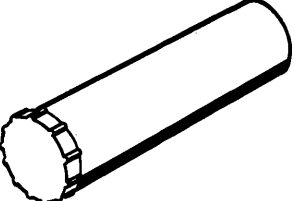
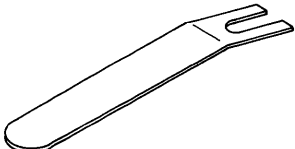
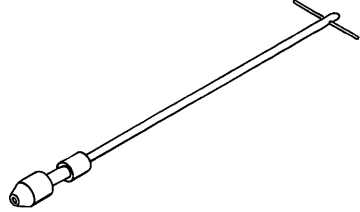
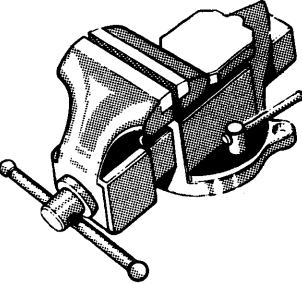
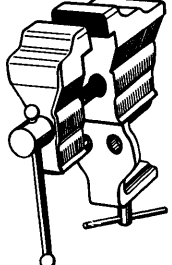
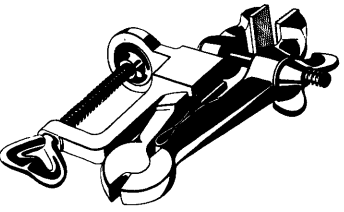
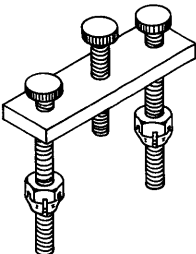
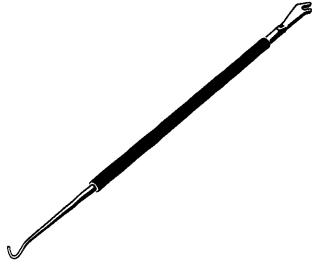
Group 7

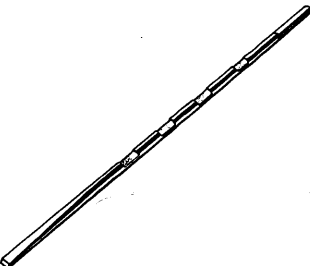
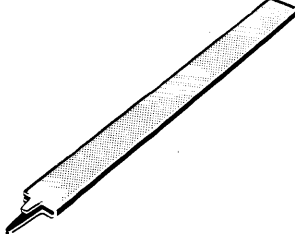
 <p>453144 INSERT/EXTRACT TOOL, TROS TAPE</p>	 <p>453506 EXTRACTOR AMP 305141-1 2108398 PIN EXTRACTOR AMP 305183</p>	 <p>2108493 TAPER PIN EXTRACTOR AMP 380305-2</p>
 <p>171320 FINGER, MECHANICAL FLEXIBLE</p>	 <p>*489949 GRIPPER MAGNET 489942 HULL, GRIPPER MAGNET</p>	 <p>2108733 EXTRACTOR, DIAMOND PIN</p>
 <p>450529 WRENCH, TAP AND REAMER EXTENSION</p>	 <p>450182 VISE, MACHINISTS, 4 IN. JAW</p>	 <p>450626 VISE, BENCH, CLAMP BASE, 3 IN. JAW</p>
 <p>*489019 VISE, BENCH, CLAMP BASE, 1.40 IN JAW</p>	 <p>2200205 DRUM PULL TOOL 2321</p>	 <p>154230 SPRING, HOOK</p>
 <p>450540 SPRING HOOK, SMALL CROCHET</p>	 <p>450030 HOOK, SPRING</p>	 <p>452815 EXTRACTION, TOOL, AMP 91017</p>

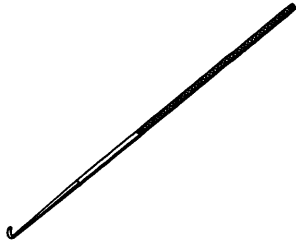

9900105 SMALL SPRING HOOK

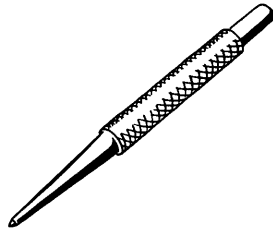

4031 CENTER PUNCH

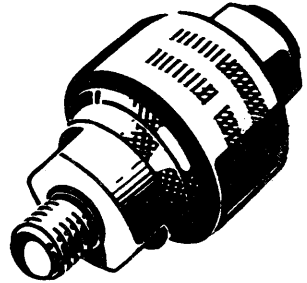

460139 PUNCH AND DIE, KNOCKOUT, 7/8 IN DIA
460169 PUNCH AND DIE, KNOCKOUT, 1-3/8 IN DIA
461161 PUNCH AND DIE, KNOCKOUT, 1.188 IN DIA

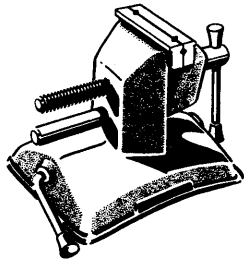

451912 VISE, VACUUM HOLDING

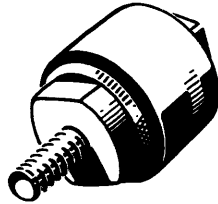

450514 PUNCH, HOLE CUTTER, 1-1/16 IN DIA

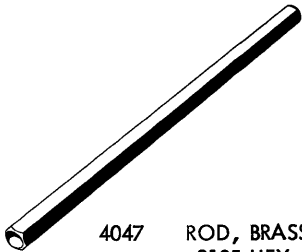

4047 ROD, BRASS, .3125 HEX - 6 IN
450546 ROD, BRASS, 3/4 HEX - 20 IN

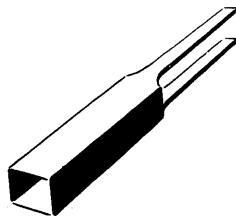

453509 EXTRACTION TOOL, AMP 126056 - 1

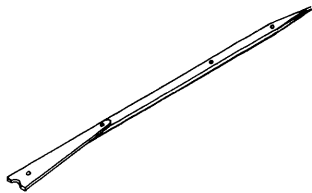

453521 INSERT-EXTRACT TOOL, C-CLIP

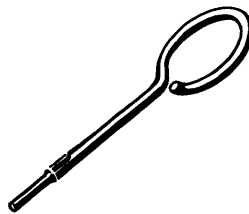

2127892 INSERT TOOL, AMP CONNECTOR

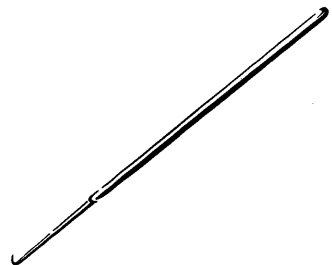

9900254 SPRING HOOK, INSULATED

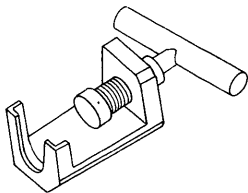

2200026 REMOVAL TOOL, PIN 2321

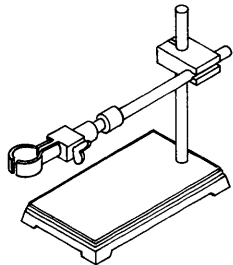

224036 VISE, HOLDING, LIGHT PEN 1500



9900210 SPRING HOOK, HOLDING

Group 7

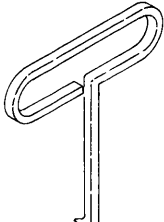
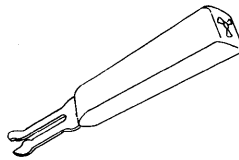
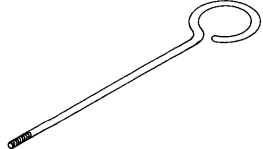
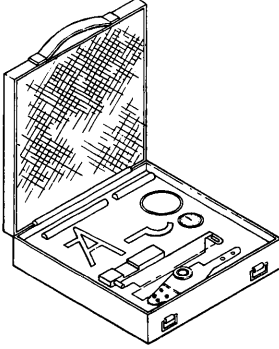
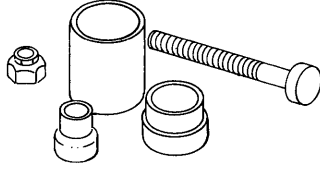
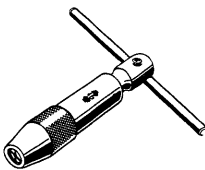
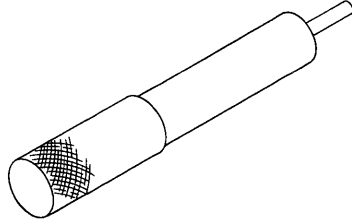
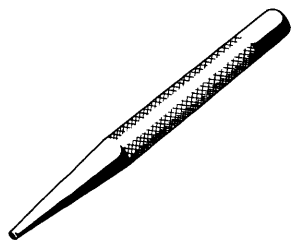
 <p>2704117 EXTRACTOR , CARD SYS 7</p>	 <p>2200103 APPLICATION , E-RING 2314</p>	 <p>2200066 HOOK , STRIP RELEASE PLUNGER</p>
 <p>2515401 REEL MOTOR REPLACEMENT KIT 2420</p>	 <p>9900523 SELECTRIC I-O CENTER BEARING KIT</p>	 <p>4046 WRENCH , TAP AND REAMER , ADJUSTABLE</p>
	 <p>2494907 BUSHING DRIVE , CE TOOL</p>	 <p>4032 PUNCH, DRIVE PIN, 1/8 X 10 IN 4035 PUNCH, DRIVE PIN, .187 X 4 IN 157189 PUNCH, DRIVE PIN, 1/4 X 8 IN 157199 PUNCH, DRIVE PIN, 3/16 X 18 IN 157200 PUNCH, DRIVE PIN, 3/32 X 18 IN 450391 PUNCH, DRIVE PIN, .094 X 4 IN 450407 PUNCH, DRIVE PIN, .0625 X 4 IN 450448 PUNCH, DRIVE PIN, .050 X 3-1/2 IN 450456 PUNCH, DRIVE PIN, 3/32 X 8 IN SPL 450457 PUNCH, DRIVE PIN, 9/32 X 8 IN SPL 460303 PUNCH, DRIVE PIN, 1/8 X 8 IN SPL 460315 PUNCH, DRIVE PIN, .060 X 6 IN 605908 PUNCH, DRIVE PIN, .055 X 10.5 IN</p>

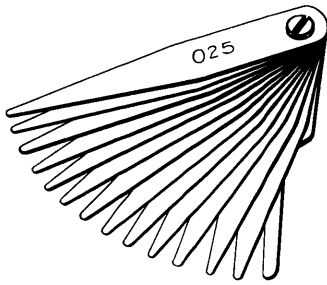

450745 GAUGE, THICKNESS,
.001-.030 IN.

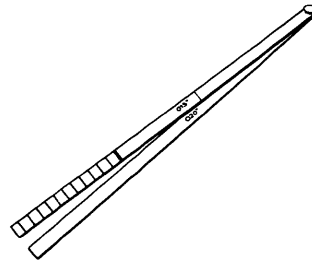

450544 GAUGE, THICKNESS,
.015-.020 IN.

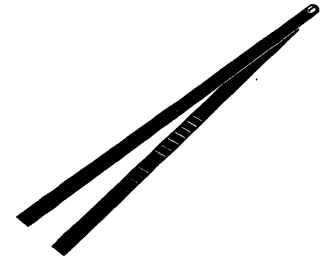

105668 GAUGE, CHUTE BLADE,
0125-.018 IN.

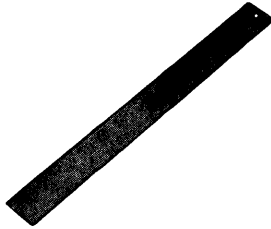

450961 GAUGE, ADJUSTING,
FEED ROLL, .0065 IN.

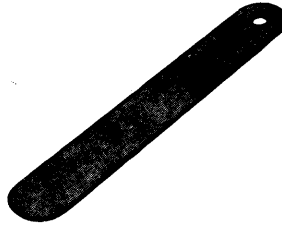

461162 GAUGE, THICKNESS,
.005 IN., ERASE HEAD
MOUNT

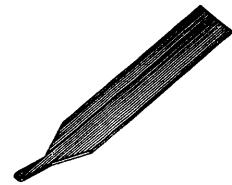

626532 FEELER GAUGE, 0.0010
THK LATCH 1442

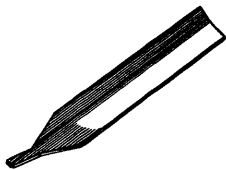

626533 FEELER GAUGE, 0.0020
THK 1442

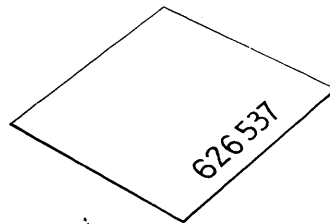

626537 INTERPOSER MAGNER
GAUGE

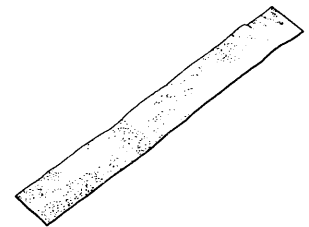

2108142 GAUGE, HEAD CLEARANCE,
305

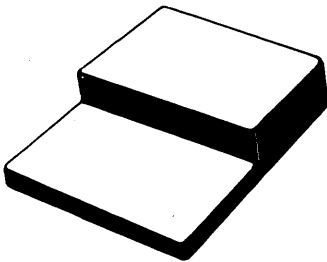

11234 GAUGE, CHUTE BLADE
HORIZONTAL SORTER

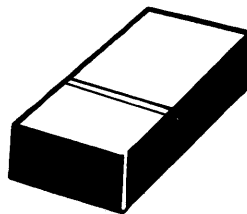

10480 GAUGE, CARD FEED KNIFE,
GO-NO GO

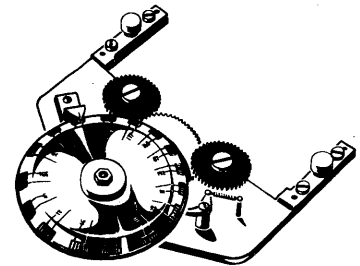

**123635 GAUGE, COUNTER
402-405

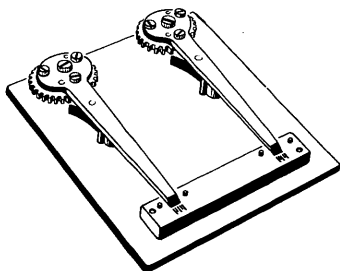

123228 GAUGE, COUNTER SPOOL

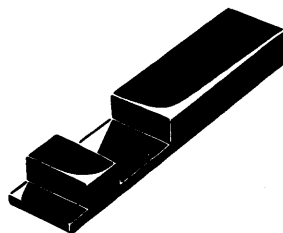



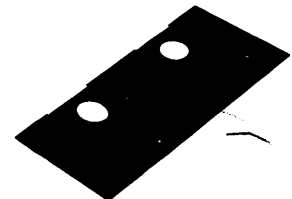

150246 GAUGE, BLOCK,
COMPT PRINTER,
801-2-3

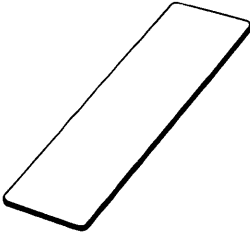
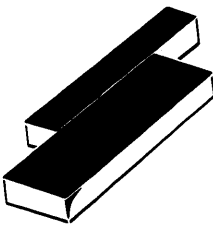
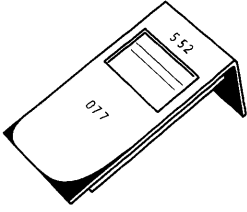
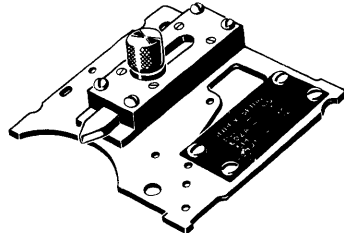
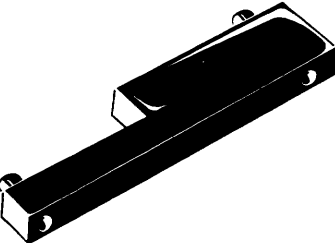
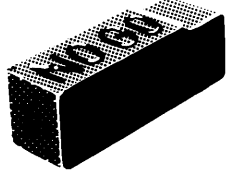
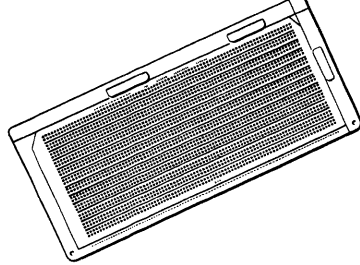

158333 GAUGE, CARD HOPPER

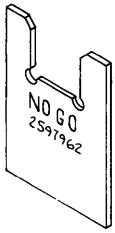
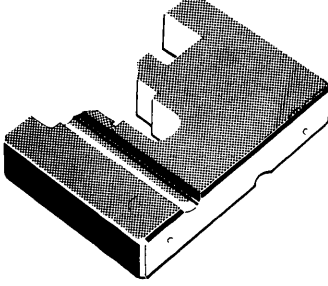
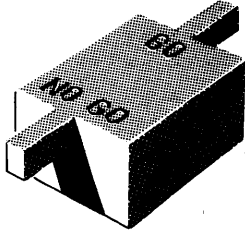
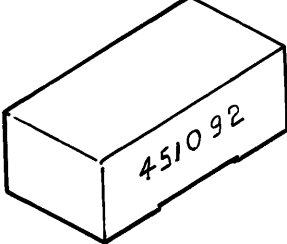
Group 8

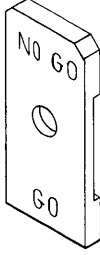
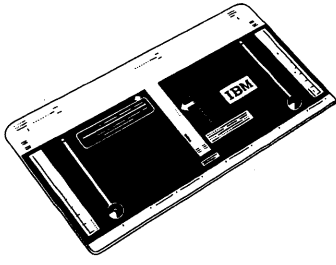
 <p>GAUGE, CLUTCH ADJ, BANK PROOF 158603 .0625 THK 158602 .015 THK</p>	 <p>450366 GAUGE, FEED KNIFE ADJ, BILL FEED</p>	 <p>450388 JIG, BRUSH SETTING</p>
 <p>450434 GAUGE, GEAR POSITION</p>	 <p>450428 GAUGE, INTERPRET ASSEMBLY</p>	 <p>450541 GAUGE, FEED KNIFE, .009 IN. CARD</p>
 <p>450550 GAUGE, PUNCH CARD</p>	 <p>450584 GAUGE, GO-NO GO, BILL FEED</p>	 <p>2597962 GAUGE, TYPE WEAR</p>
 <p>450856 GAUGE, LEVEL GEAR DRIVE 077</p>	 <p>451065 GAUGE, GO-NO GO, COMMON BAR</p>	 <p>451092 GAUGE, CARD READER FEED WHEEL</p>
 <p>451128 GAUGE, PLASTIC, PRINTERS</p>	 <p>2597940 GAUGE, CLU</p>	 <p>451590 GAUGE, REGISTRATION, 1418</p>

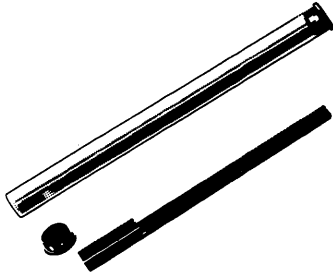

451600 GAUGE, M.R. LOCATING

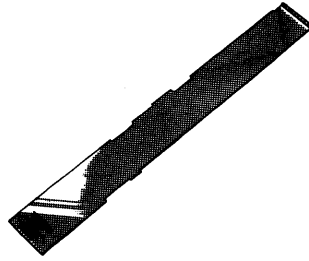

451893 HAMMER CHAIN ALIGNMENT GAUGE

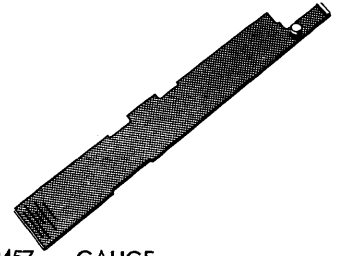

452457 GAUGE, HAMMER-CHAIN ALIGN, 1403/3, 1403/N1



454321 GAUGE, CLOSURE MECHANISM

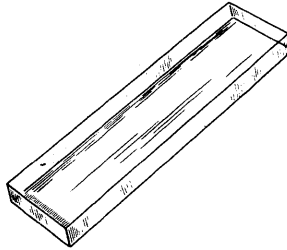

454326 GAUGE, DUPLICATING BRUSH

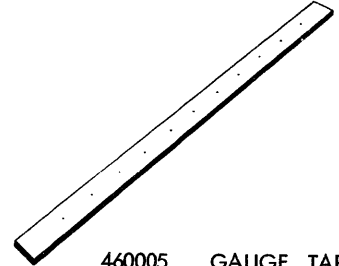

460005 GAUGE, TAPE REGISTRATION 063, 163

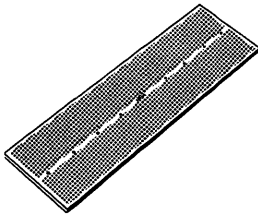

460008 GAUGE, PROGRAM TAPE REGISTRATION



460025 GAUGE, PROGRAM DRUM

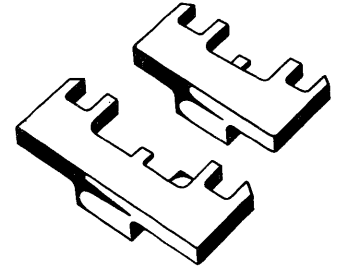

GAUGE, ADDING UNIT
460192 802
460193 803

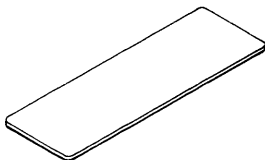

461707 GAUGE, TAPE GUIDE

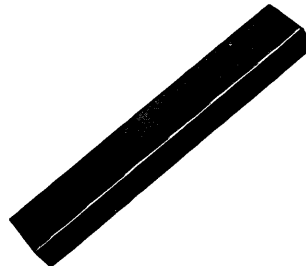

460961 GAUGE, BLOCK, 727

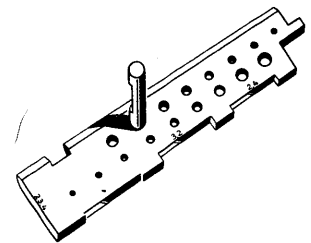

*489824 GAUGE, MULTIPLE USE

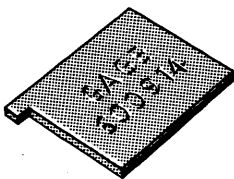

600914 INTERPOSER SET-UP BAIL GAUGE

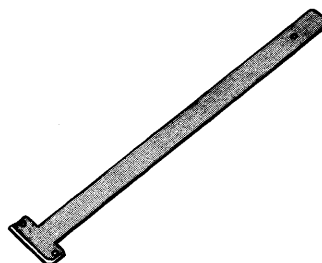

605905 GAUGE, UPPER PENDANT GEAR ALIGNER

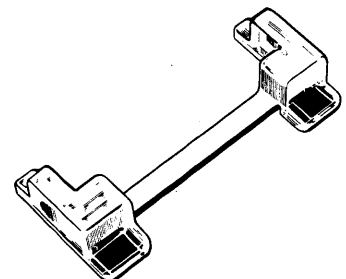

608183 GAUGE, INTERMITTENT ROLL

Group 8

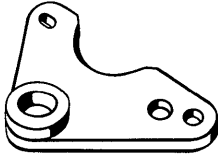

610147 READER CLUTCH GAUGE

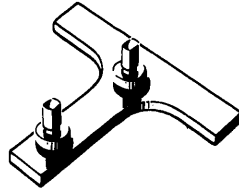

610692 SQUARENESS GAUGE

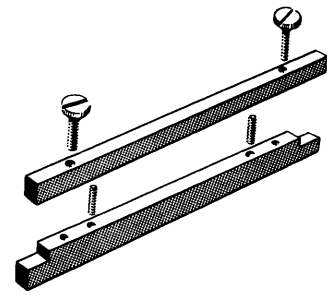

613898 STEPPED FEED ROLL TIMING GAUGE

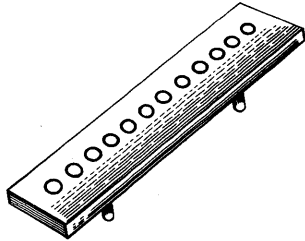

627700 GAUGE, LAMP POSITION

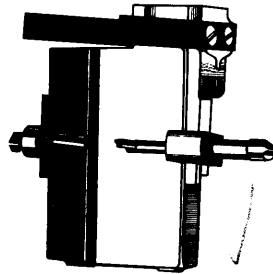

804720 GAUGE, HEAD ALIGNING

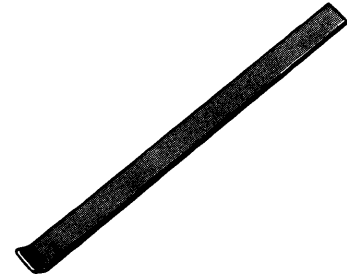

2108495 GAUGE, REVERSE INTERPOSER

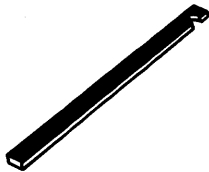

2108496 GAUGE, ESCAPE INTERPOSER

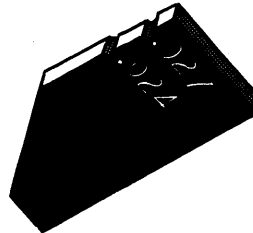

2108497 GAUGE, PUNCH PENETRATION

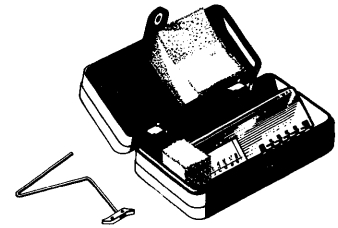

2108627 GAUGE, DISK PACK RUNOUT

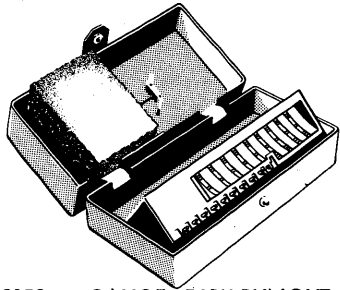

2200050 GAUGE, DISK RUNOUT 1130
2200102 GAUGE, DISK PACK RUNOUT 2314

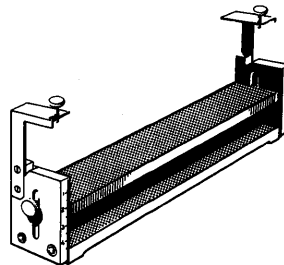

*4261050 BRUSH SETTING GAUGE

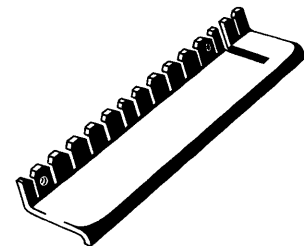

450419 GAUGE, BRUSH SETTING SCREW, FOR 450419
58284

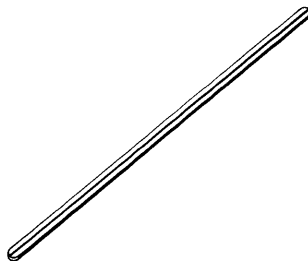

8105577 SLIP GAUGE 047-.055 IN.

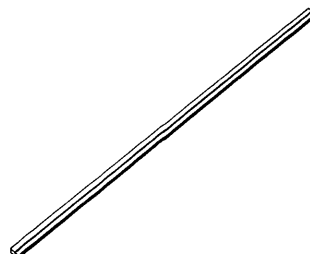

8106305 SLIP GAUGE 049 IN

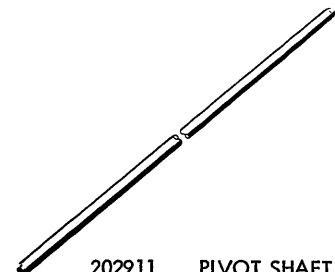

202911 PIVOT SHAFT, PRINT UNIT 407

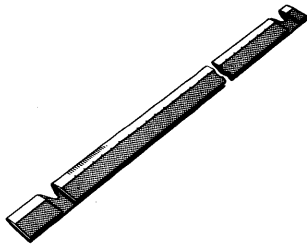

220710 TYPE WHEEL ALIGNER,
407

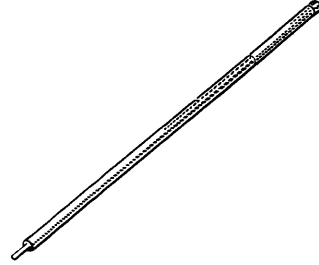

442618 ROD, ACCESS SUPPORT,
1405

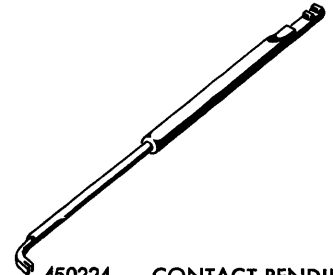

450224 CONTACT BENDING
TOOL, SELECTOR

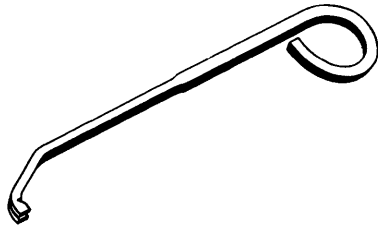

450364 BRUSH BENDING TOOL

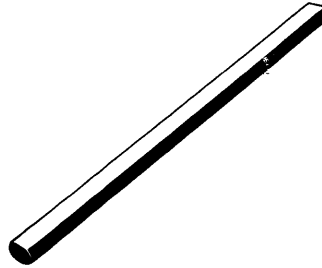

450367 BAR, DRUM CAM GUIDE

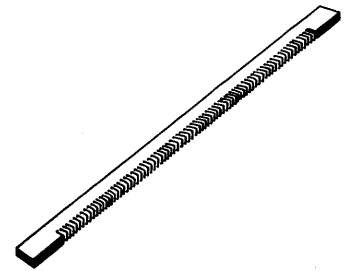

450674 BAR, ALIGNING

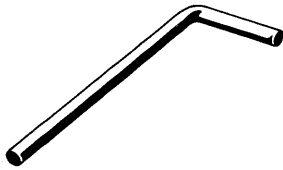

450827 TIMING PIN, BENT

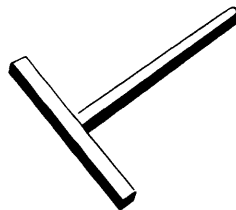

451617 ALIGNING TOOL

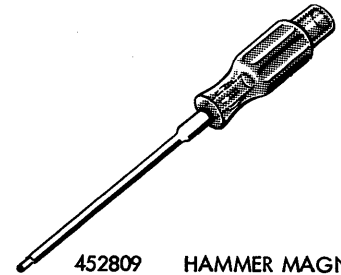

452809 HAMMER MAGNET
ADJ TOOL
HEX .093

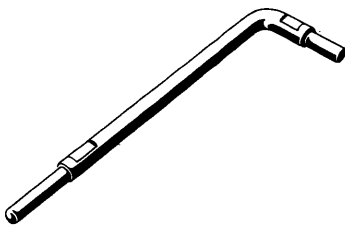

454325 TIMING TOOL,
120 DEG,
407, 557

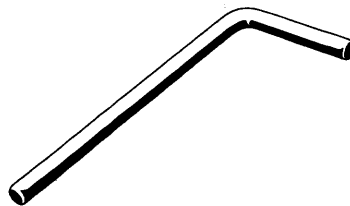

460028 ALIGNING TOOL,
CODE PLATE

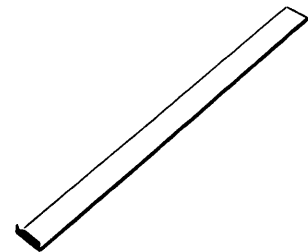

472752 ALIGNING TOOL,
RIBBON GUIDE

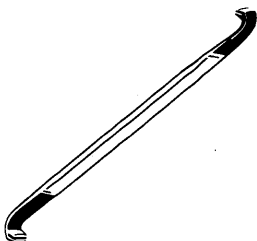

*489150 ADJUSTING TOOL,
CONTACT SPRING

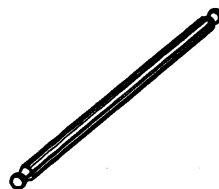



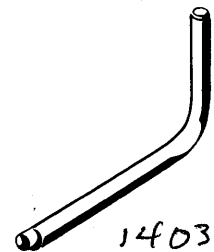

612704 TIMING ROD

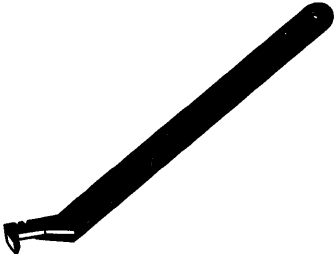
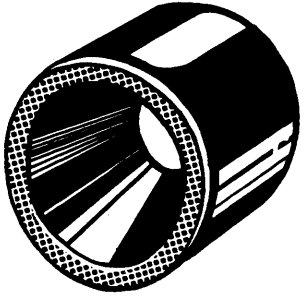
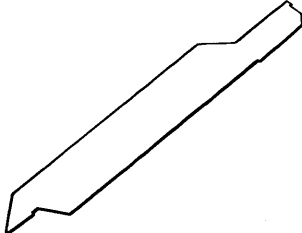
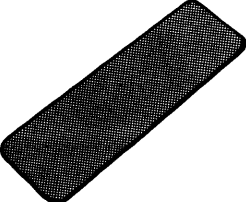
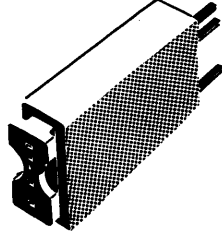
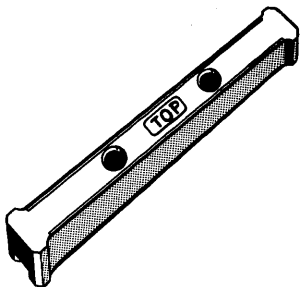
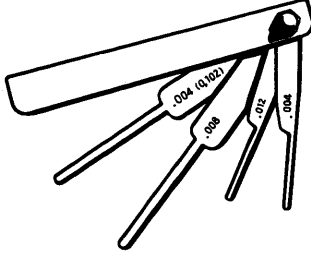
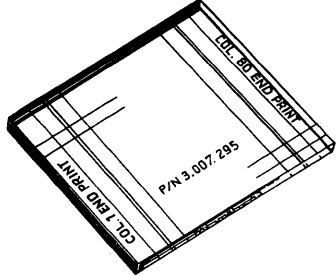
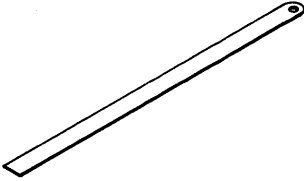

1403 N1
856170 ADJUSTING TOOL,
SOLAR CELL

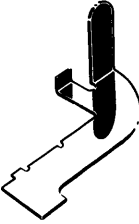
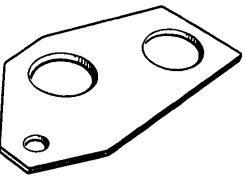
Group 8

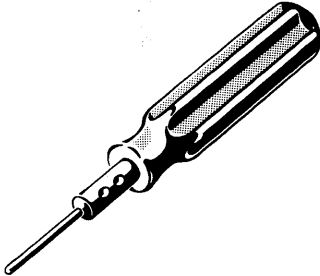
 <p>9900240 GAUGE, WIRE FEELER .008 X 6 9900241 GAUGE, WIRE FEELER .012 X 6</p>	 <p>2108625 TRACK PULSE ADJ. TOOL</p>	 <p>2108633 RING, CARRIAGE FIELD REPLACEMENT 1311/2311</p>
 <p>2108634 ARM, CARRIAGE FIELD REPLACEMENT 1311/2311</p>	 <p>2108912 HEAD ALIGNMENT SHIM, 2311</p>	 <p>2108913 HEAD ALIGNMENT ADAPTER, 2311</p>
 <p>610094 DIE CARD GUIDE GAUGE</p>	 <p>637931 FEELER GAUGE</p>	 <p>3007296 PRINTING REGISTRATION GAUGE</p>
 <p>450517 GAUGE, CHUTE BLADE 024 IN.</p>	 <p>5831638 GAUGE, HEAD HEIGHT</p>	 <p>451147 GAUGE, STACKER ADJUSTING</p>
 <p>451208 RESTRAINT TOOL, BELT INSTALLATION</p>	 <p>453160 TIMING TOOL, 029-059</p>	 <p>452813 MAGNET ADJ. TOOL 452811 BLADE FOR 452813</p>

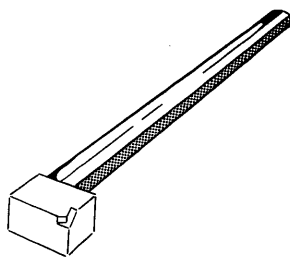

9900375 DYNAMIC HALF-CYCLE TOOL

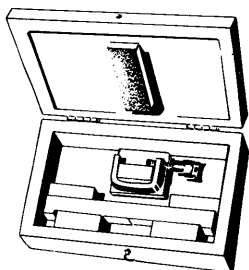

461395 ALIGNING TOOL, REEL HUB, HYPERTAPE

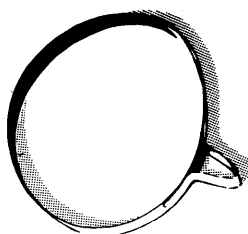

461453 GAUGE, RING, QUICK RELEASE DEVICE 729

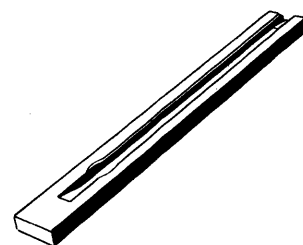

8105962 PIN ALIGNING TOOL, 029 MOD C

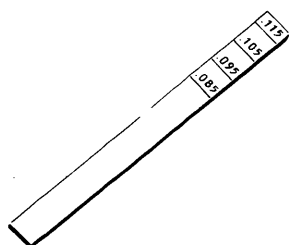

2108576 GAUGE, CARRIAGE SPACING 1301

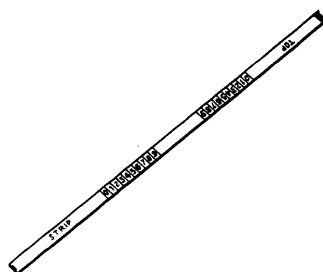

605901 GAUGE, SET-UP RATCHET READING

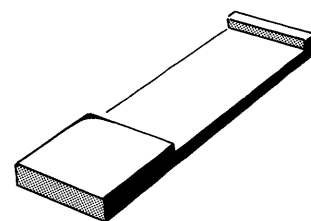

834308 GAUGE, SEPERATOR GUIDE 1419

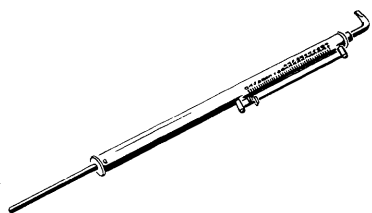

2108578 GAUGE, FORCE, 0-40 LBS., 1301

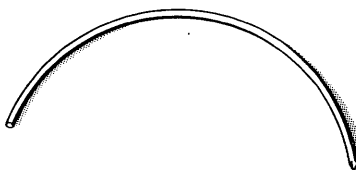

2106718 WIRE, TYPEBAR FULCRUM, TYPEWRITER
1000502 WIRE, CAM UNIT FULCRUM, TYPEWRITER

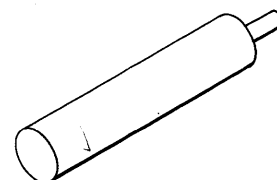

2108577 GAUGE, HEAD LOAD

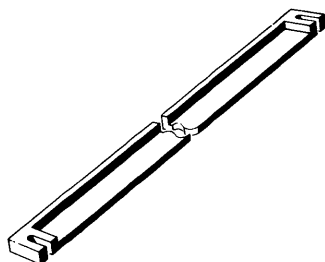

231034 GAUGE, TYPEWHEEL ALIGNING

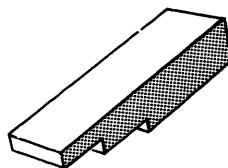

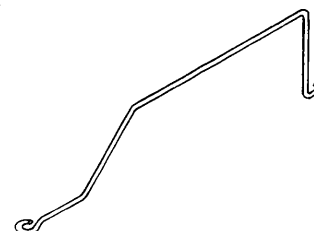

399123 GAUGE, STACKER GUIDE, 1219/1419

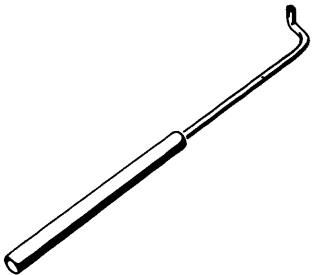
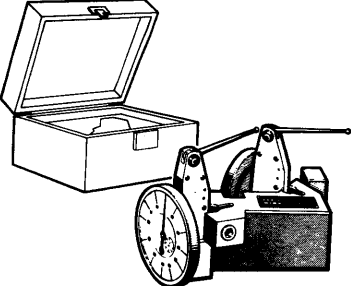
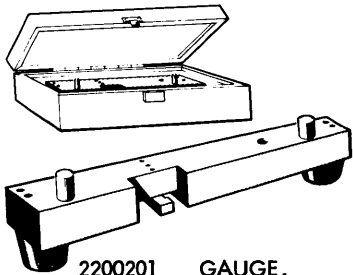
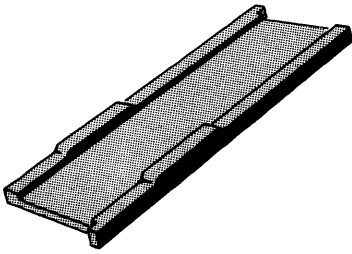
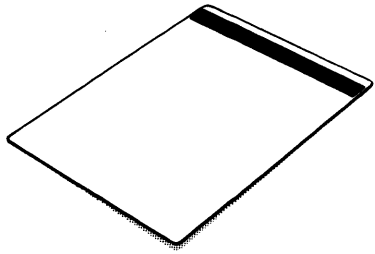
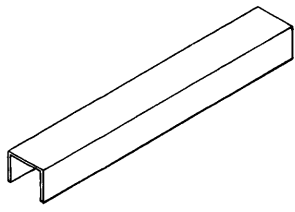
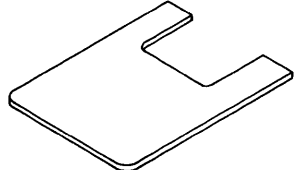
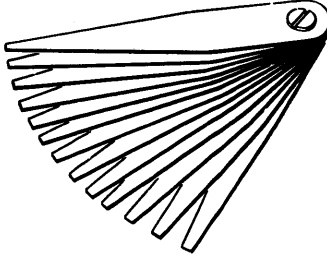
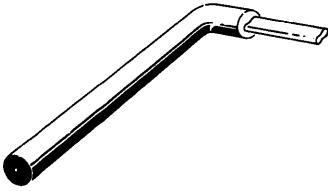
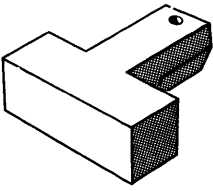
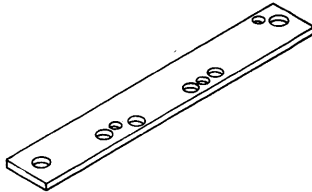
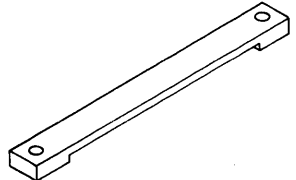
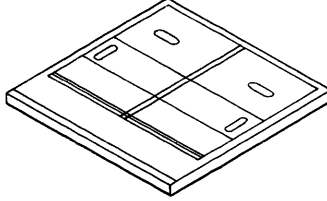
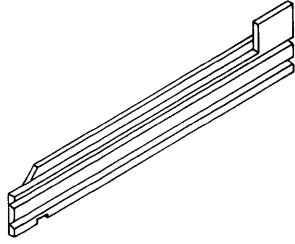

2191421 ADJUSTING TOOL, CONTACT 1134

Group 8

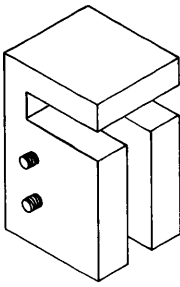
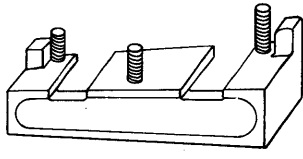
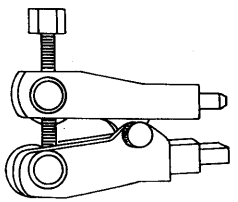
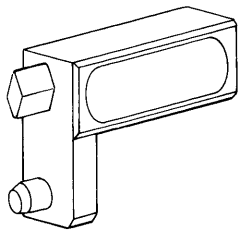
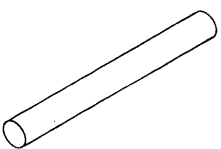
 <p>9900263 STRAP BENDER DUO RELAY</p>	 <p>**2200166 DIAL PROTRUSION INDICATOR, 2321</p>	 <p>2200201 GAUGE, STRIP HOUSING, 2321</p>
 <p>9900166 GAUGE, STAR WHEEL</p>	 <p>9900217 MASTER CARD, MAGNETIC LEDGER</p>	 <p>461193 BAR, SERVICING, PROOF CONTACT 557</p>
 <p>2108791 GAUGE, CRASH STOP</p>	 <p>640830 GAUGE, THICKNESS 2560</p>	 <p>641503 MAGNET ADJ. TOOL 2520</p>
 <p>2108507 GAUGE, ESCAPE ASM. MOUNTING</p>	<p>640782 BLADE, REPLACEMENT .001</p> <p>640783 BLADE, REPLACEMENT .002</p> <p>640784 BLADE, REPLACEMENT .003</p> <p>640785 BLADE, REPLACEMENT .004</p> <p>640786 BLADE, REPLACEMENT .005</p>	 <p>625287 GAUGE, PINWHEEL ADJUSTMENT 1050</p>
 <p>477169 GAUGE, TYPEWHEEL ALIGNING 557</p>	 <p>628848 GAUGE, DOCUMENT ASSEMBLY</p>	 <p>452507 GAUGE, MARK READ LAMP</p>

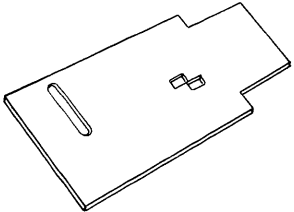
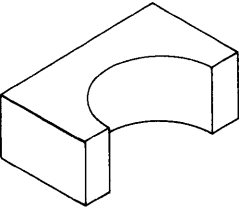
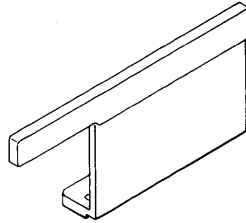
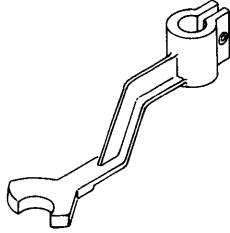
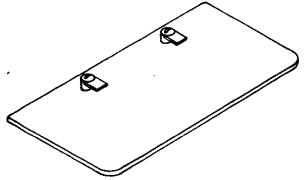
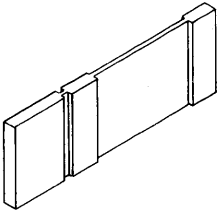
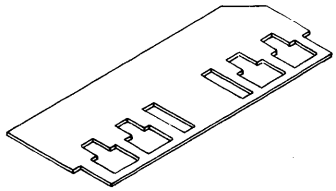
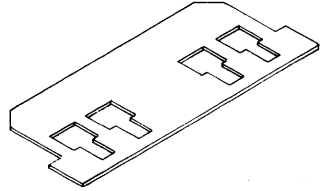
 <p>641155 GAUGE, PRINT HEAD</p>	 <p>2200430 HEAD INSTALLATION TOOL</p>	 <p>2200432 HEAD ALIGNMENT TOOL</p>
 <p>2200440 INITIAL HEAD ALIGNMENT TOOL</p>	 <p>259746 ACTUATOR PIN GAUGE</p>	 <p>2536581 FEELER GAUGE 0.003 IN 2536582 FEELER GAUGE 0.004 IN 2536583 FEELER GAUGE 0.005 IN 2598179 FEELER GAUGE 0.007 IN 2598040 FEELER GAUGE 0.010 IN 2598041 FEELER GAUGE 0.014 IN 2598042 FEELER GAUGE 0.016 IN</p>
 <p>5994204 THROAT GAUGE 357, 1030</p>	 <p>857385 GAUGE, SECTOR ASM 1241, 1421, 1979, 1419</p>	
 <p>845430 GAUGE, SELECTOR LOCATING 1219, 1419, 1998, 1979, 1241</p>	 <p>451207 ALIGNING TOOL, PRESSURE PAD</p>	 <p>804460 GAUGE ASM, POCKET PLATFORM 1219, 1419, 1241</p>
 <p>847859 GAUGE, MULTIPLE DETECTION GUIDES 1419, 1998, 1979</p>	 <p>451531 GAUGE, LOCATION, INNER 1210, 1412</p>	 <p>451530 GAUGE, LOCATING, OUTER CARD LEVER 1210, 1412</p>

Group 8

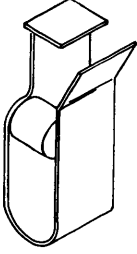
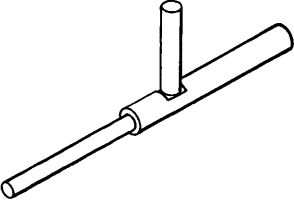
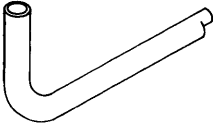
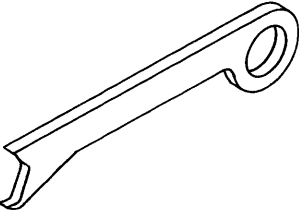
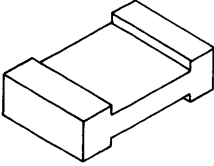
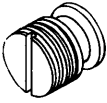
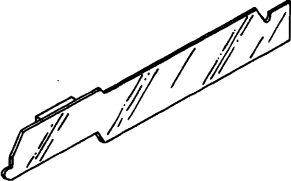
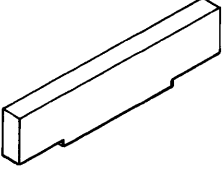
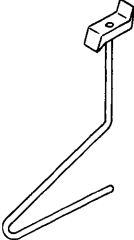
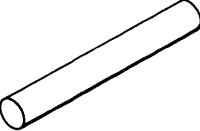
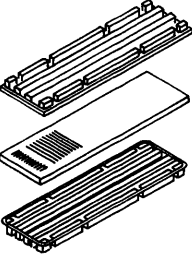
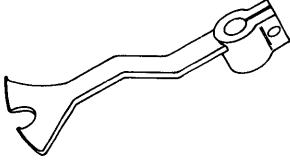
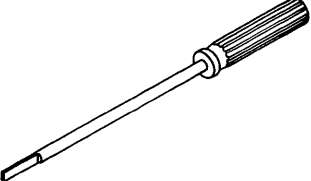
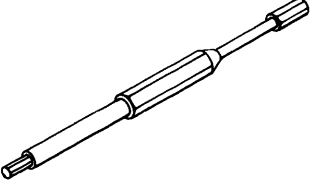
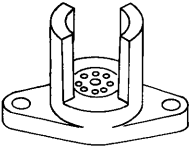
 <p>650867 ADJUSTING TOOL, EMITTER 1260</p>	 <p>650823 TIMING TOOL 1260</p>	 <p>857450 ADAPTER ASM, CE AID 1210, 1219</p>
 <p>857440 TYPEWHEEL TOOL 1210, 1412</p>	 <p>630237 GAUGE, BLOCK RESTRAINT ADJ 1230, 1231, 1232</p>	 <p>399147 GAUGE, REFLECTANCE, SCREW ASM 1419, 1998, 1979</p>
 <p>5831644 ALIGNMENT TOOL, ACTUATOR</p>	 <p>641508 ADJUSTMENT TOOL, REG GATE</p>	 <p>2108621 POINT ASM, DISK RUNOUT GAUGE</p>
 <p>450756 PIN TIMING, STRAIGHT</p>	 <p>2360173 PRINT ALIGNMENT TOOL</p>	 <p>808540 ALIGNING TOOL, CE PRESSURE 1219</p>
 <p>2247662 ALIGNMENT TOOL, 8 IN LG</p>	 <p>2572882 ADJUSTMENT TOOL, POT</p>	 <p>302132 PIN STRAIGHTER, ELECTRON TUBE, 7-PIN</p>

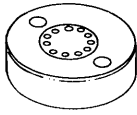

460881 PIN STRAIGHTER,
ELECTRON TUBE, 9-PIN

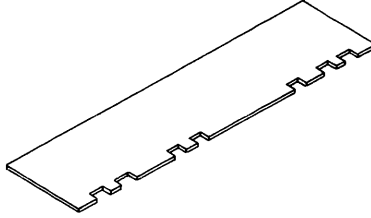

806565 HOPPER POST AND PICKER
KNIFE ADV TOOL 1404

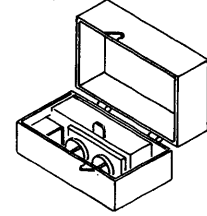

2200209 GAUGE, DEFLECTION
SPRING 2361

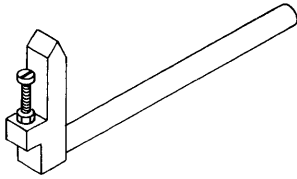

453604 REDUCED FUNCTION TOOL,
HALF CYCLE SEL I/O

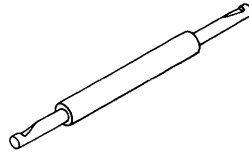

9900253 BENDING TOOL, INSULATED
SEL I/O

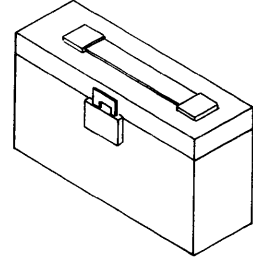

2200028 GAUGE, SPINDLE HEIGHT
2321

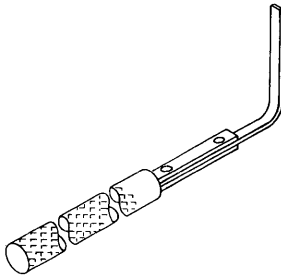

2200144 GAUGE ASM, STRIP REL
2321

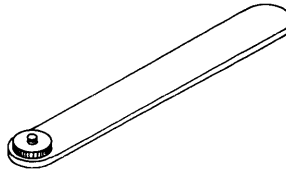

2200058 RESOLVER TOOL, ZERO ADJ
2321

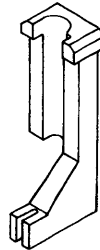

2200590 GAUGE, RETRACT
3330

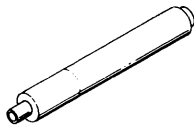

2200119 ADJUSTING TOOL,
INTERMEDIATE SPEED
2314 DASF

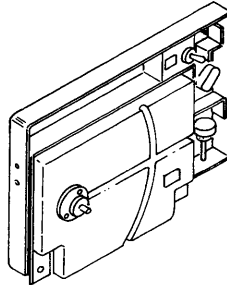

2200113 PACK INSPECTION TOOL
2314 DASF

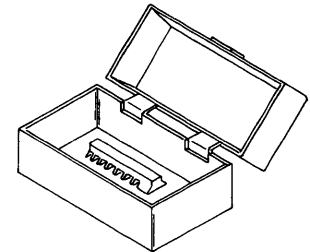

2200111 KIT ASM, HEADGAUGE
2314

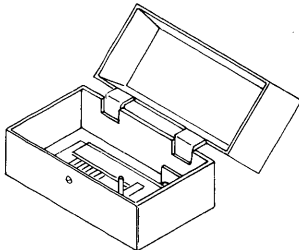

2200109 GAUGE, RUNOUT
2314 DASF

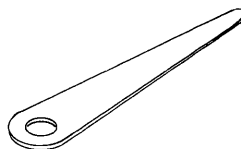

2200105 GAUGE, SHROUD CENTERING
2314

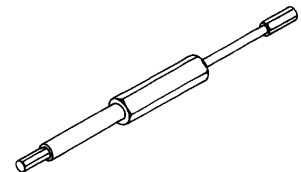

5728554 ADJUSTMENT TOOL, POT
1900

Group 8

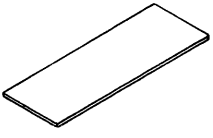
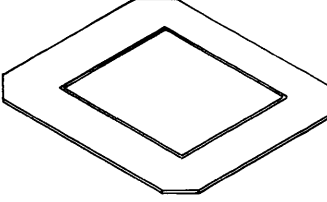
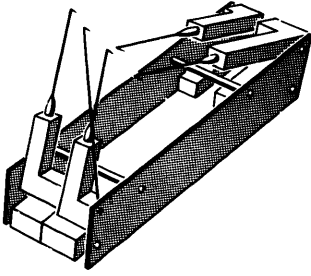
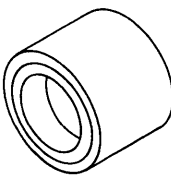
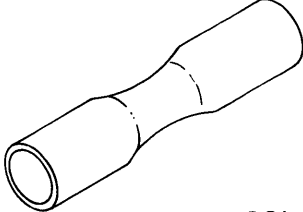
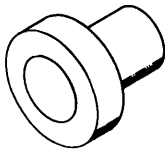
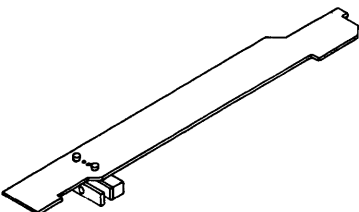
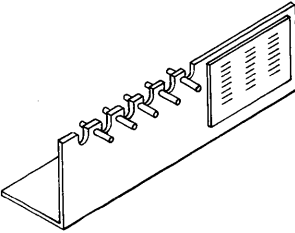
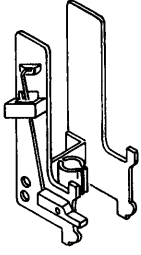
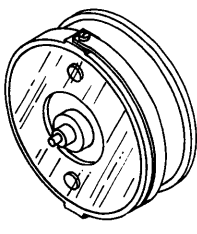
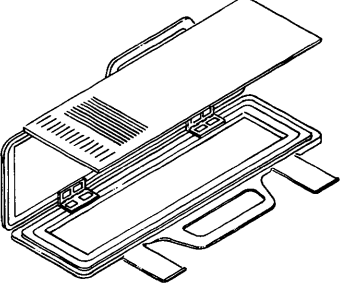
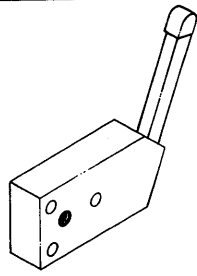
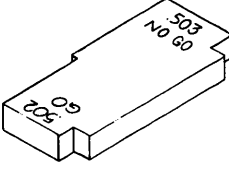
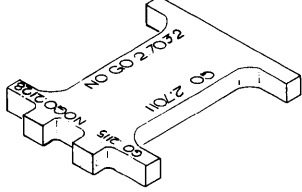
 <p>2229272 GAUGE, FILM GUIDE 1512</p>	 <p>2229268 MASK, ALIGNMENT 1510</p>	 <p>453523 GAUGE ASSEMBLY, WIRE SEL I/O 453524 GAUGE, WIRE-.005 453525 GAUGE, WIRE-.008 453526 GAUGE, WIRE-.010 453527 GAUGE, WIRE-.012 453528 GAUGE, WIRE-.015 453529 GAUGE, WIRE-.018 453530 GAUGE, WIRE-.020 453531 GAUGE, WIRE-.028</p>
 <p>2248032 ADJUSTING TOOL, REFLECTOR 1500</p>	 <p>2248040 ADJUSTING TOOL, INSULATED POT 1500</p>	
 <p>2515376 ALIGNMENT TOOL, CAPSTAN 2420</p>	 <p>2200326 ALIGNMENT TOOL ASM, CARRIER 1502</p>	 <p>2108595 GAUGE ASM, DISK RUNOUT</p>
 <p>2536591 GAUGE, RUNOUT 5444</p>	 <p>2537550 HUB ASSEMBLY 5444</p>	 <p>2360173 PRINT ALIGNMENT TOOL ASSEMBLY</p>
 <p>2517735 TOOL-REEL HUB ADJUSTMENT</p>	 <p>2517648 GAUGE-GO, NO GO, TAPE GUIDE</p>	 <p>**2631570 GAUGE-RAIL, CAM AND CARRIER</p>

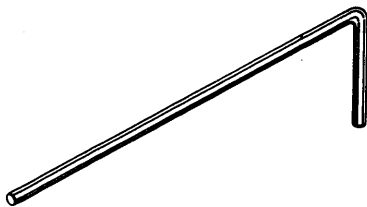

2533723 CAPSTAN ADJ TOOL
3420

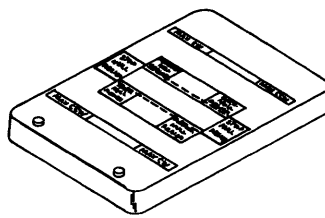

2517722 TOOL-HALF COLUMN COVER

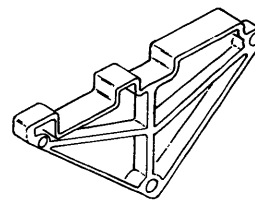

2517647 TOOL TAPE INDICATE
LOCATOR

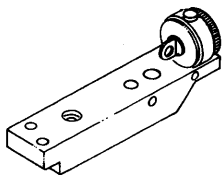

2515226 TOOL ASM-FILE,
REEL SET-UP

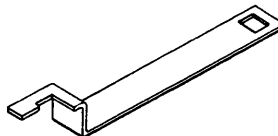

852342 ALIGNER TOOL,
1ST 8.17 LG
1219, 1419, 1241

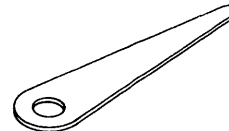

2200006 GAUGE, FEELER-0.002
IN RAMKIT
2200007 GAUGE, FEELER-0.005
IN RAMKIT
2200057 GAUGE, FEELER-0.007
IN RAMKIT 305

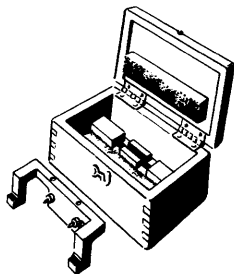

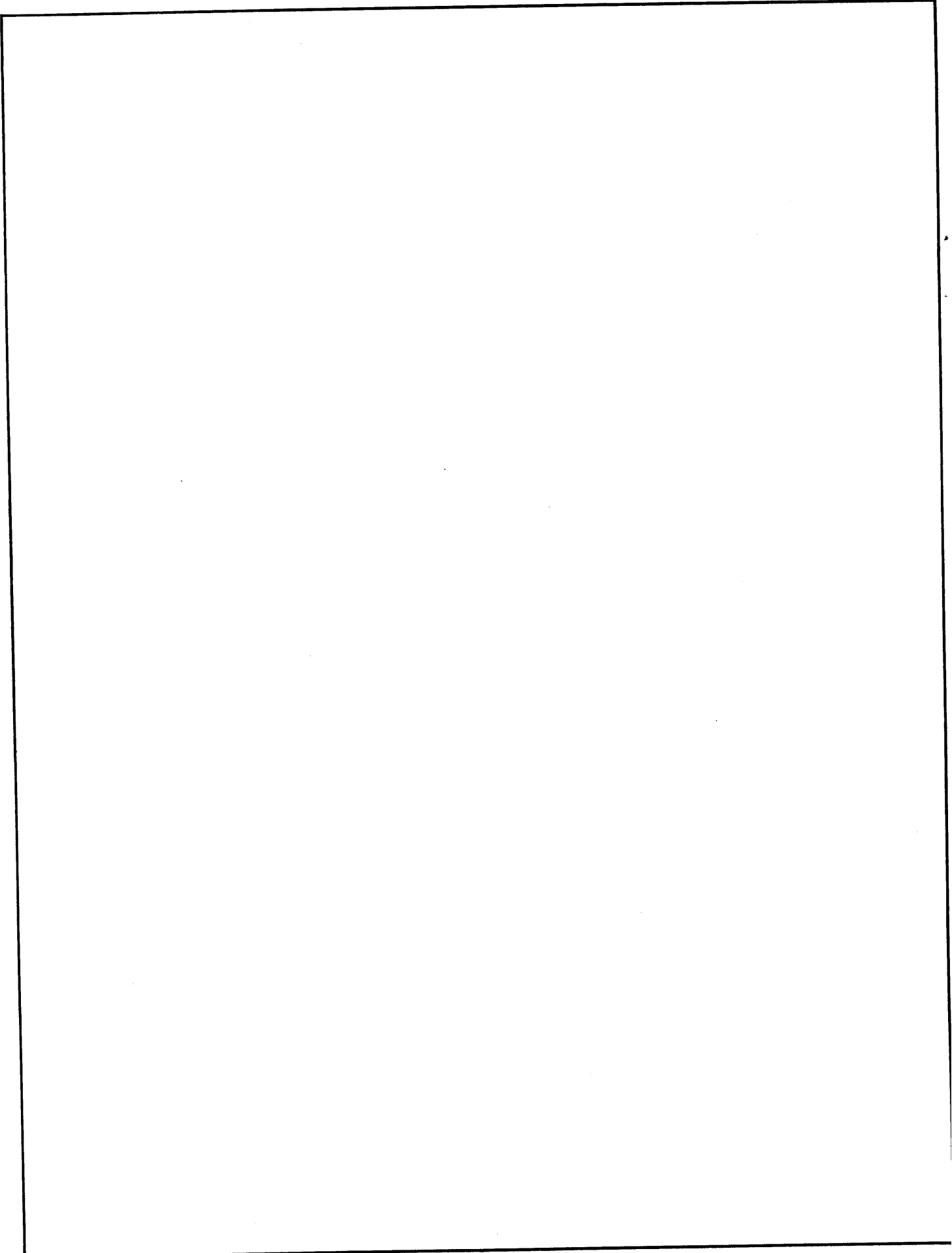

**461392 GAUGE, HEAD LOCATING
7340
**461616 GAUGE, HEAD LOCATING
7340-3

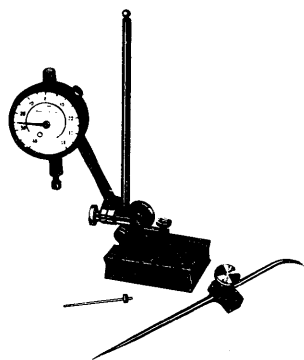
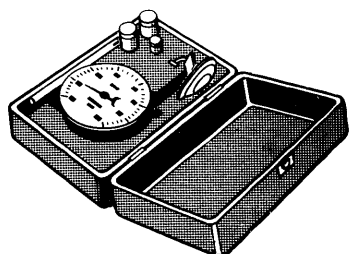
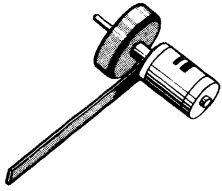
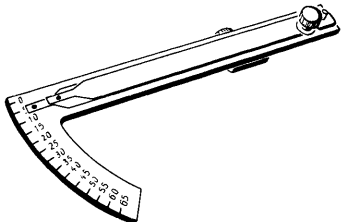
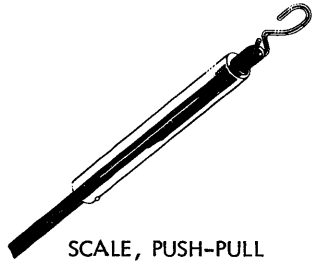
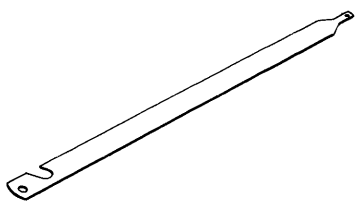
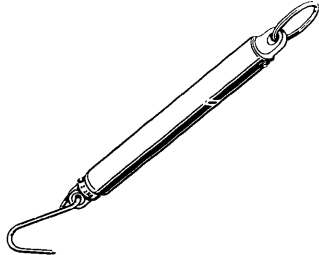

 <p>152831 INDICATOR, SPEED ROTATION 450574 TIP, SPEED INDICATOR, CONE 450575 TIP, SPEED INDICATOR, FLAT</p>	 <p>2108617 GRAM GAUGE, 0-50</p>	 <p>450949 INDICATOR ASSEMBLY, DIAL, WITH STAND 450948 POINT, DIAL INDICATOR</p>
 <p>451126 TACHOMETER, HAND, SINGLE RANGE</p>	 <p>461117 TACHOMETER ASM, ELECTRIC, GENERATING</p>	
 <p>806533 HOOK, FEED ROLL, SPRING SCALE</p>	 <p>450976 TACH. GENERATOR CARR. 667329 TACH/GEN, SHAFT ADAPTER 1287 253826 CAPACITOR 1 MF 451290 GEN. COUPLING 1311, 1403 451921 GEN. COUPLING 720, 1443 2538084 TACH. COUPLING 5444 2538137 TACH. BRACKET 5444 2600559 TACH. CAPACITOR 5444</p>	 <p>857459 THERMOMETER, 0 DEG. F TO 220 DEG. F</p>
 <p>450459 SCALE, GRAM, ASSEMBLY 451914 BLADE, X1 GRAM SCALE, 451915 BLADE, X10 GRAM SCALE,</p>		 <p>SCALE, PUSH-PULL 460870 0-6 LB 9900012 0-3 LB</p>
 <p>BLADE 450916 X2 GRAM SCALE, FOR 450459 451049 X20 GRAM SCALE, FOR 450459 9900265 X5 GRAM SCALE, FOR 450459</p>	 <p>* 489898 SPRING SCALE 2, 5 KG</p>	 <p>461141 SCALE, PUSH-PULL, 0-10 LB</p>

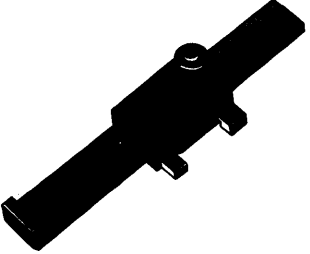
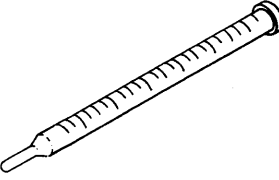
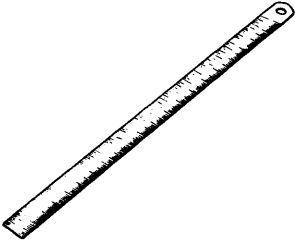
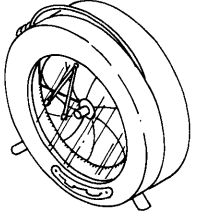
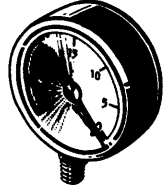
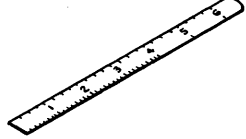
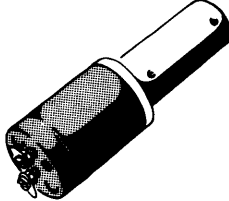
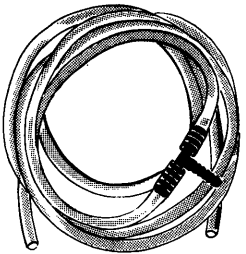
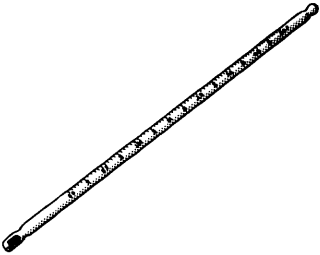
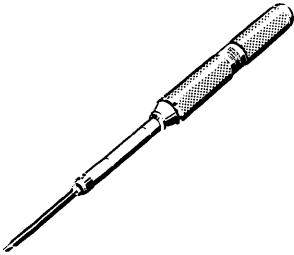
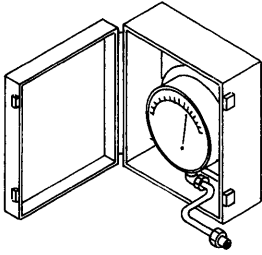
Group 9

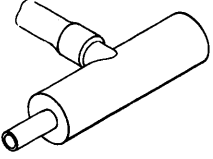
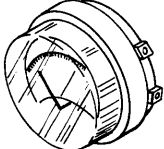
 <p>9900112 HOOVEROMETER</p>	 <p>762637 THERMOMETER, MEMORY</p>	 <p>*489185 RULER 200 MM, 8 IN.</p>
 <p>**453539 THERMOMETER, RECORDING HUMIDIGRAPHS</p>	 <p>363480 VACUUM GAUGE</p>	 <p>450158 SCALE, POCKET, 6 IN.</p>
 <p>450919 GENERATOR, TACHOMETER ELECTRIC</p>		 <p>453504 TEE AND HOSE FITTING</p>
 <p>*4611153 THERMOMETER</p>	 <p>848204 SCREWDRIVER, TORQUE BIT, TORQUE SCREWDRIVER FOR 848204</p>	 <p>2200040 GAUGE, PNEUMATIC SYSTEM</p>
 <p>2200294 GAUGE, DIFFERENTIAL PRESS 2314 DASF</p>	 <p>2513154 DIVIDER AND HOSE ASM 2420</p>	 <p>5258784 MANOMETER, PRESSURE GAUGE TAPE DRIVES</p>

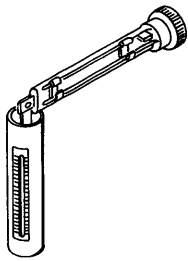

453543 SLING, PSYCHROMETER

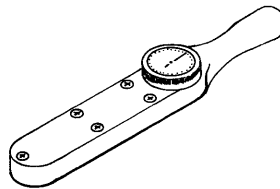

2108039 WRENCH, TORQUE
3/8 IN DR, 0-600 IN LB.
2515283 WRENCH, TORQUE,
3/8 IN DR, 0-150 IN LB.

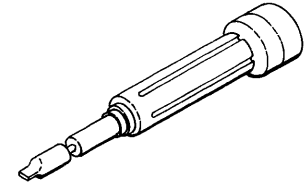

2597967 WRENCH, TORQUE, 10 IN LB,

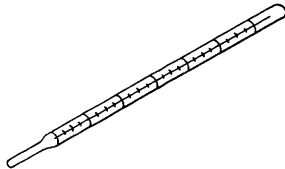

5392366 THERMOMETER 0 DEG. F TO
120 DEG. F 1800
5258786 THERMOMETER, 100 DEG. F TO
180 DEG. F. 2361

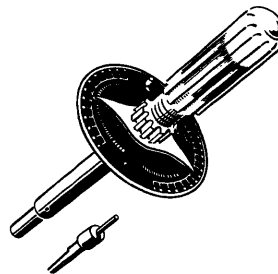

461450 SCREWDRIVER, TORQUE,
0-6 INCH POUNDS
453570 SCREWDRIVER, TORQUE,"
0-48 INCH POUNDS

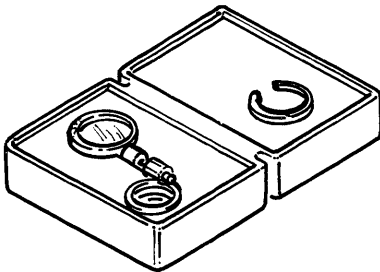

5495384 VAC PRESS GA. KIT
2108312 BOX PLASTIC
5495385 GAUGE 30" VAC
80" PRESSURE
2111942 CONNECTOR
2512794 HOSE 30" PRESSURE
2512088 HOSE 8"

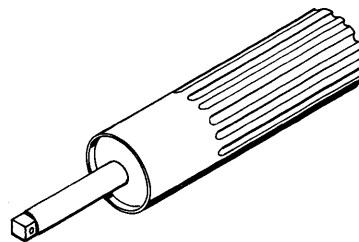

2538009 TORQUE WRENCH, ADAPTER
2598187 TORQUE WRENCH, 8 IN-LB
2597969 TORQUE WRENCH, 4 IN-LB
2597970 SCREWDRIVER ADAPTER
2597971 6 FLUTE ADAPTER, SIZE 4-40
2286679 SCREWDRIVER USE
WITH 2598187

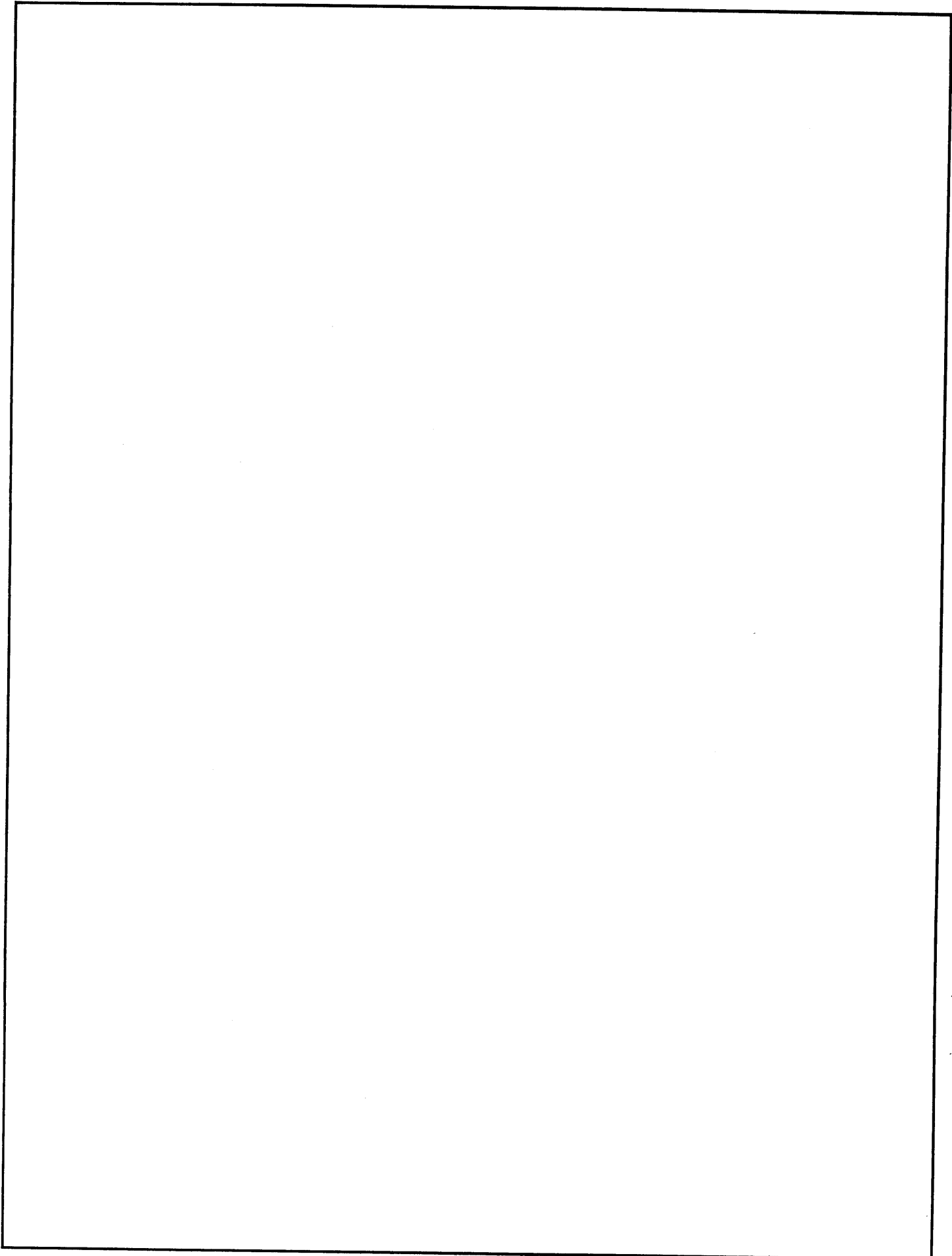



*450714 FOLDER, REPORT

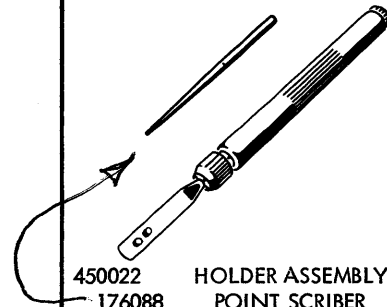
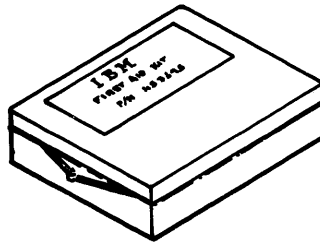

450022 HOLDER ASSEMBLY, SCRIBER
176088 POINT SCRIBER
450451 HOOK, SPRING, TYPE BAR

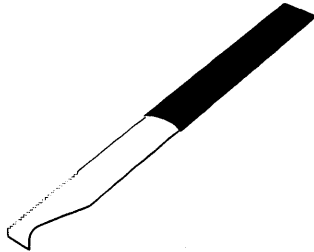

3339 CLEANER, CHUTE BLADE
961343 CARD SAW 129

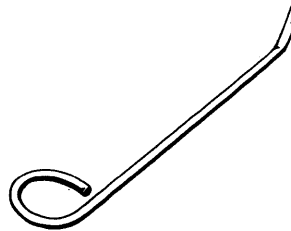

10407 BENDING TOOL,
CHUTE BLADE END

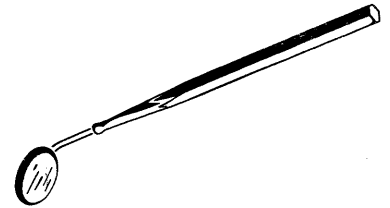

450126 MIRROR ASM, DENTAL
454323 MIRROR, HEAD, DENTAL

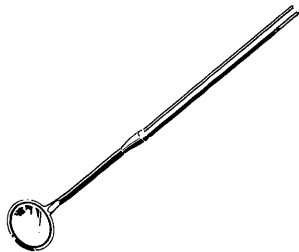

*489983 MIRROR DENTAL, INSULATED

450147 USA MANUFACTURE.
DOES NOT MEET GERMAN SAFETY REGULATIONS.

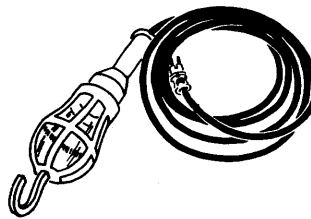

450147 LIGHT, EXTENSION

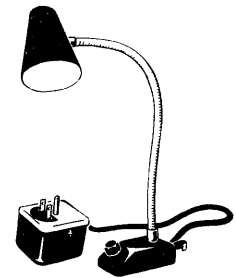

453518 LAMP, MAGNETIC BASE,
110V
2728186 REPLACEMENT BULB

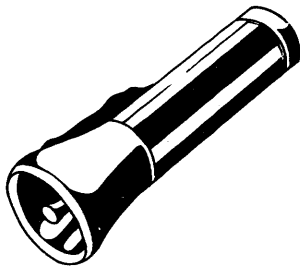

460813 FLASHLIGHT

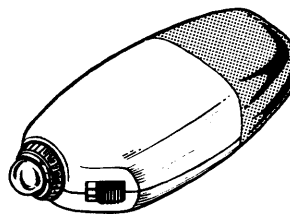

*4261076 FLASHLIGHT

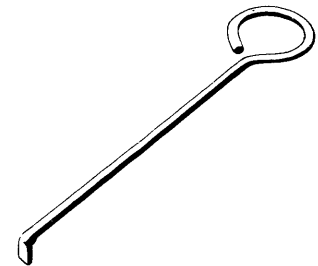

*489156 BENDER, CONTACT SPRING

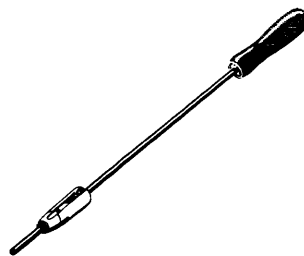



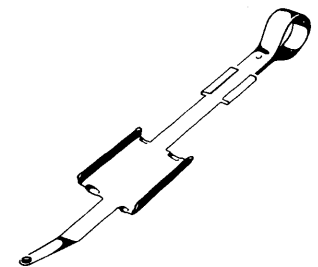



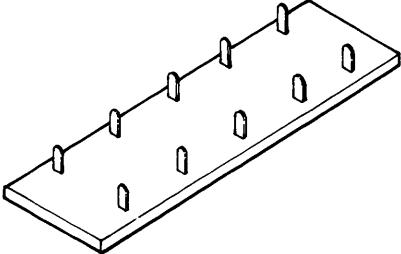
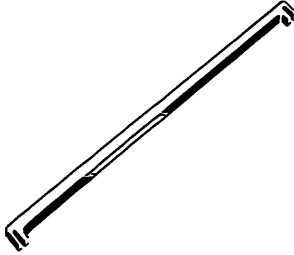
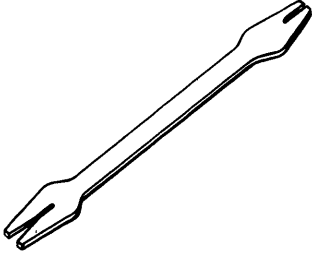

*489929 KEY WRENCH HOLDER

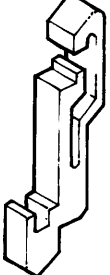
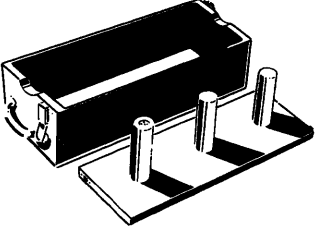

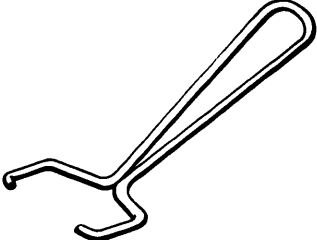
*2058581 ASM TOOL,
TYPE BAR 421 NEW

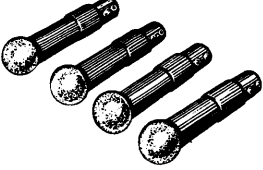
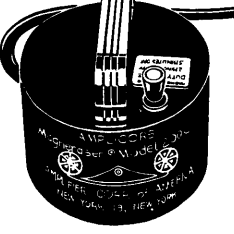
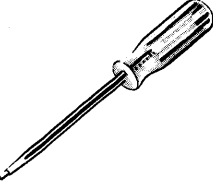
Group 10

 <p>5391007 COVER ASM, FRONT, ARRAY</p>	 <p>9900092 BENDING TOOL, TKO</p>	 <p>9900093 TYPE ALIGNING WRENCH</p>
 <p>3497 BLOCK, ADDING WHEEL</p>	 <p>129111 EJECT TOOL 129118 COLLET</p>	 <p>2537562 CLIP, CARTRIDGE SUPPORT</p>
 <p>450634 HOLDER, SPINDLE BLOCK AND SHAFT</p>	 <p>450340 DRILL, 110V 1/4 IN. CHUCK</p>	 <p>450618 BLOCK, BENCH</p>
 <p>450830 EXTRACTOR, HEAD CONNECTOR 650</p>	 <p>228993 ANALYZER TABLE, FOLDING</p>	 <p>KIT, ADJUSTING LEG, ANALYZER TABLE 451040 0-1/4</p>
 <p>451064 DEGAUSSER</p>	 <p>451123 MAGNET ADJUSTING TOOL</p>	 <p>460997 CAPSULE, POWDER, MAGNETIC MIX</p>

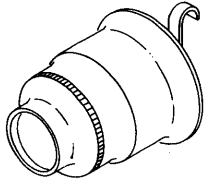

450785 MAGNIFIER, LOUPE ASSEMBLY, JEWELER

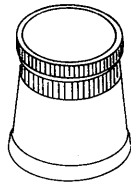

451513 MAGNIFIER, 12X COMPARATOR, W/E 138 RETICLE

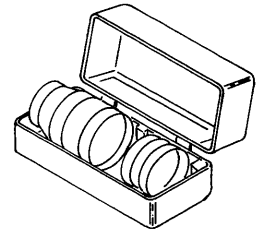

451593 COMPARATOR ASSEMBLY, 1418

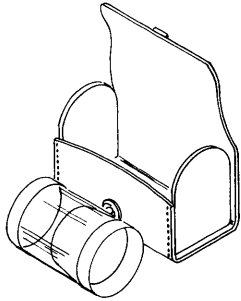

460240 MAGNIFIER, TAPE COMPARATOR

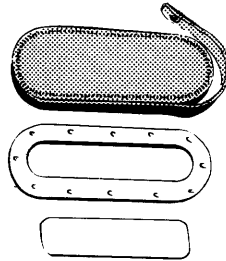

461180 VIEWER ASM, BIT AND CASE

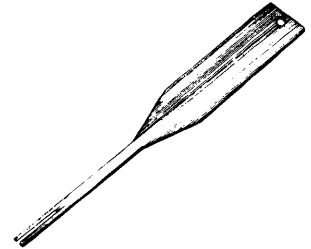

451616 THREADING TOOL, DYNAVAR

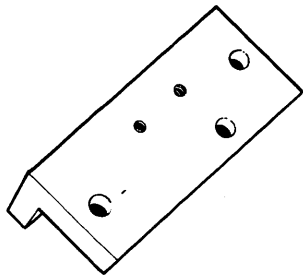

450491 JIG, DRILL, INTERPRETING REPRO



454354 HOLDER, KEY



460310 CRANK, HAND TYPE, 026

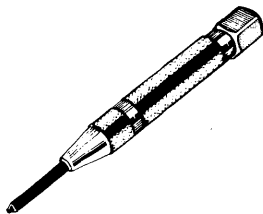

INSERT, PIN, TAPER

461064 .040-.060, GREEN
2108491 .040-.060, RED



461065 TIP, INSERTION TOOL, 22-24

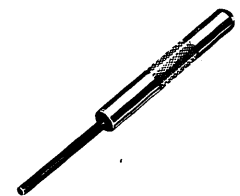

461083 INSERTING TOOL, CENTER COND, COAX

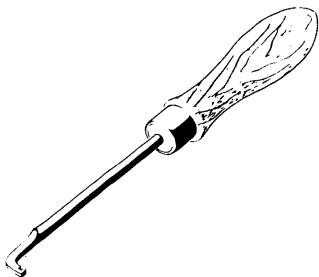

461131 ADJUSTING, SPRING

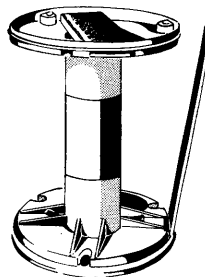



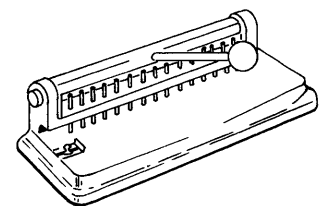

2200008 DISK CARTRIDGE CLEANING FIXTURE, 1130

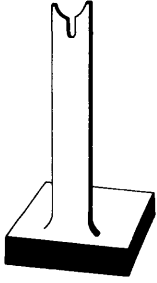
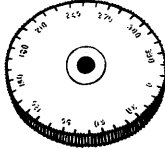
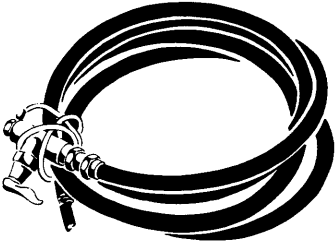

512893 PERFORATOR, PAPER, DESK, 22-HOLES

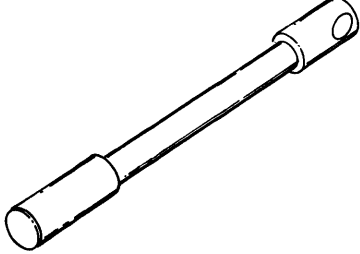
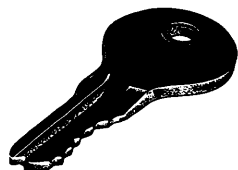
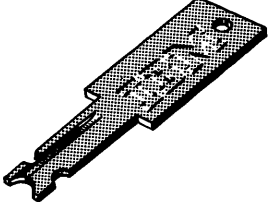
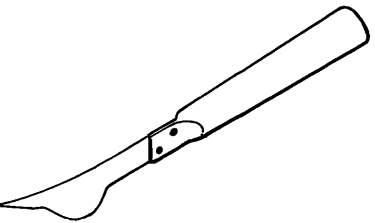
Group 10

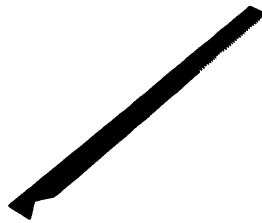
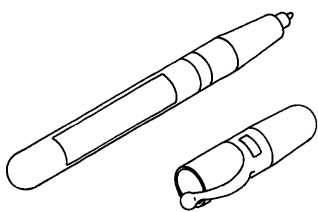
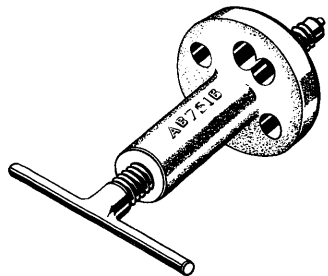
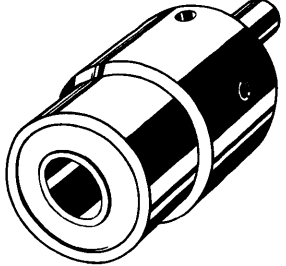
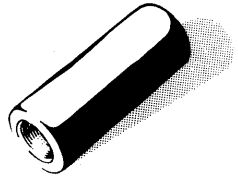
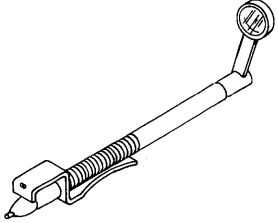
 <p>605906 FIXTURE, PIN REMOVING</p>	 <p>1145391 OPERATIONAL HAND CYCLE AND DEGREE WHEEL</p>	 <p>2108006 AIR LINE ASSEMBLY, SERVICE</p>
 <p>2108016 WIRE, SNARE, .005 DIA</p>	 <p>2200063 SCREW, RELEASE BAR</p>	 <p>KEY, LOCK 450908 MASTER, FIELD SUPPLIES 460108 CORBIN NO. 31</p>
 <p>2162866 KEY, COMPARE DISABLE 1311</p>	 <p>9900004 PICK, SEGMENT</p>	 <p>2108916 SEAL INSERTING TOOL, 2311</p>
 <p>2155623 CLEANER TOOL, TAPE GUIDE, JAM CLEARING</p>	 <p>453505 TAPE DEVELOPMENT PEN 453522 DEVELOPING SOLUTION, 1/2 PT.</p>	 <p>452391 END PLATE PULLER</p>
 <p>452392 BEARING PUSHER</p>	 <p>605967 BEARING REPLACEMENT TOOL</p>	 <p>452642 MAGNIFIER, LIGHTED 453404 BULB</p>

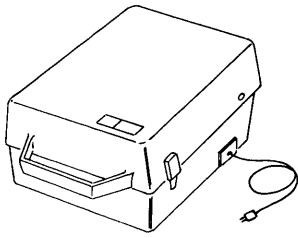

**453631 VIEWER, MICROFICHE

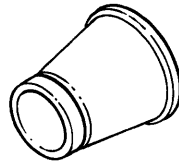

2508925 COMPARATOR, GRAPHIC ARTS 2680

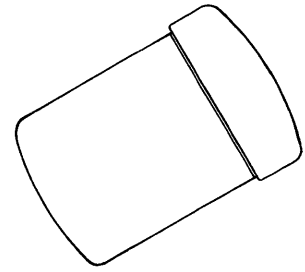

2108023 COVER, ARM AIR INLET NIPPLE

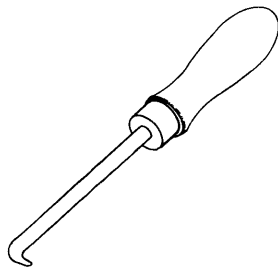

461130 ADJUSTER, SPRING, 3-3/4 IN

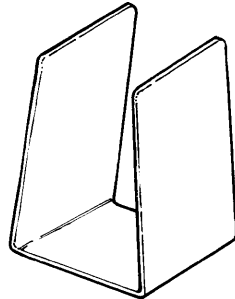

2200059 RETAINER, PUNCH MAGNET ARMATURE

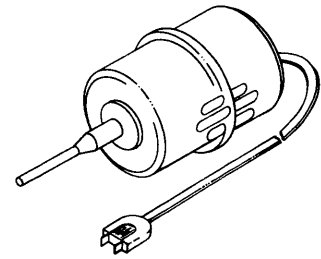

2249715 DEGAUSSOR, TAPE HEAD

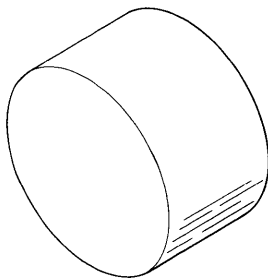

2200343 PAD, FORCE 23FD

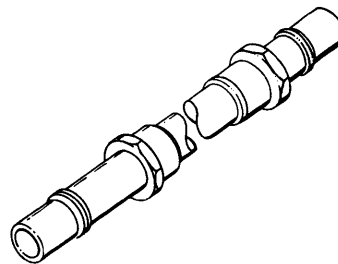

2200022 HOSE ASM, CE TOOL 2321

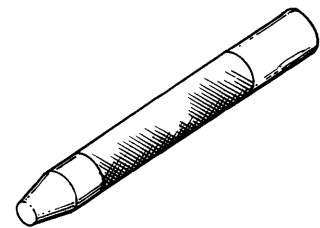

2200174 INSTALLER TOOL, PIN 2301, 2303, 7320

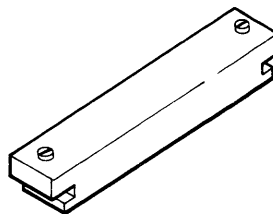

2286189 HANDLE ASM, DISK STACK INSTALLATION

4261124 GERMAN MANUFACTURE.
MEETS GERMAN SAFETY REGULATIONS.

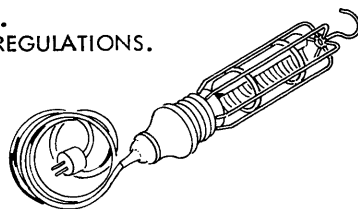

*4621124 LIGHT, EXTENSION
*4116511 BULB 110V 25W
*4116650 BULB 220V 25W

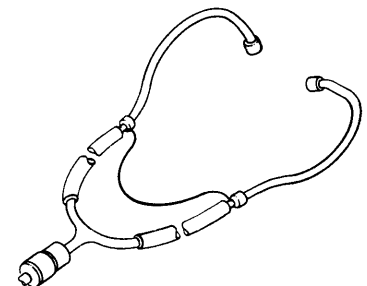

2200191 STETHOSCOPE ASM, AIR LEAK DETECTION 2301, 2303, 7320

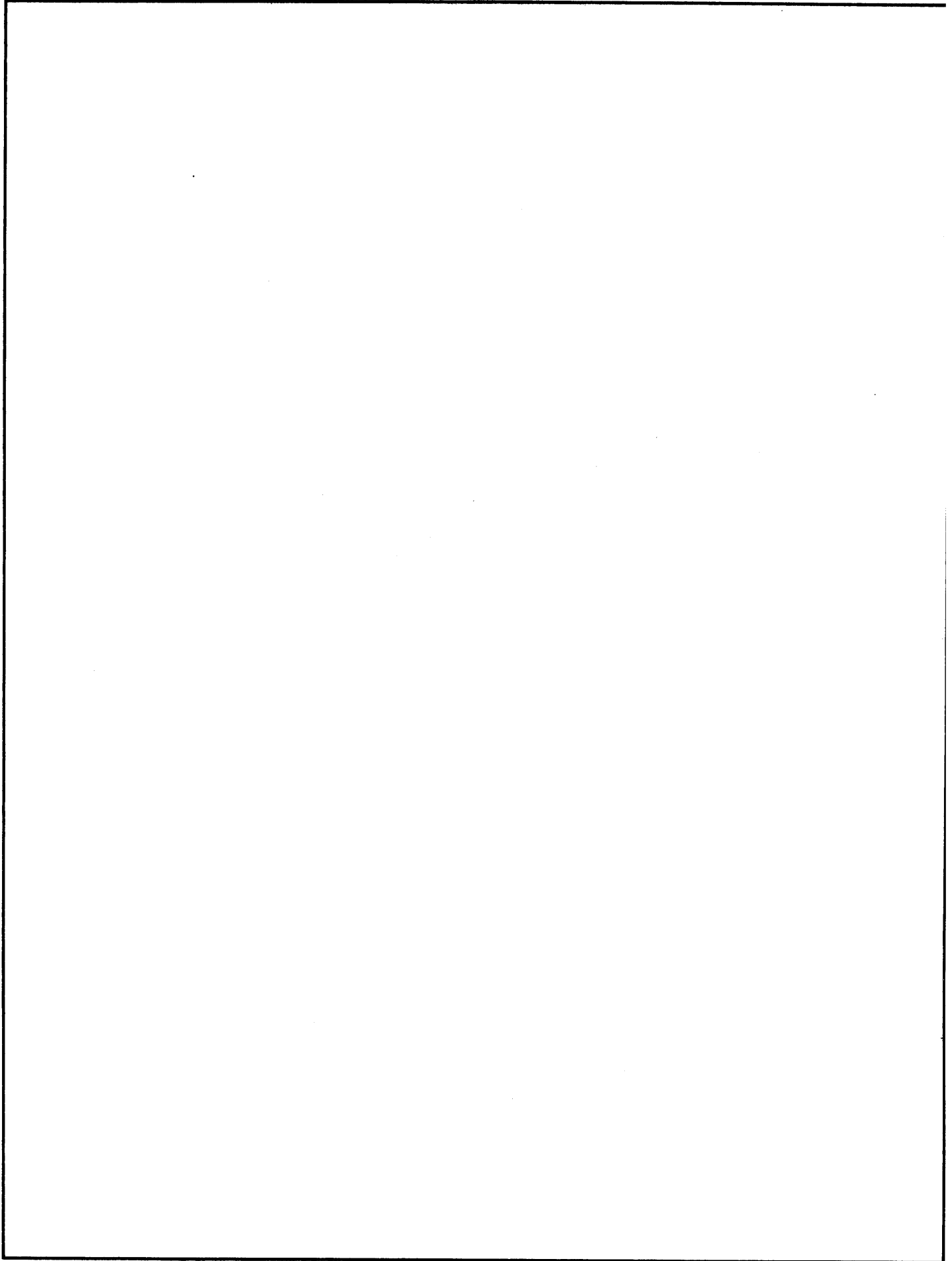



1018992 BRUSH, TYPE CLEANING

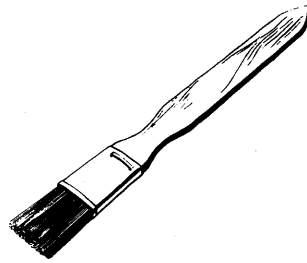

*489026 BRUSH, FLAT, 3/4 IN.

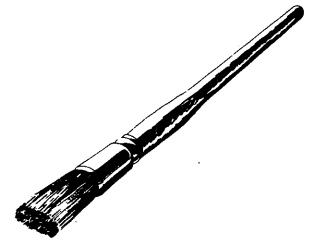

450732 BRUSH, SASH

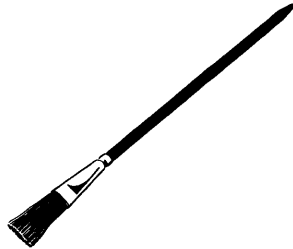

3701 BRUSH CLEANING, STRAIGHT

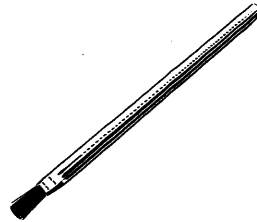

2108025 BRUSH, ACID, NO. 2



*489029 BRUSH, ROUND

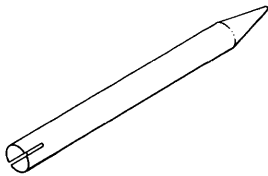

2109829 ROD, CLEANING, STRIP HOUSING

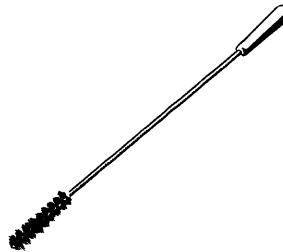

171959 BRUSH, TEST SCORE MACH

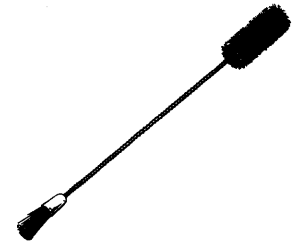

451555 CLEANING BRUSH, PHOTOCELL LAMP

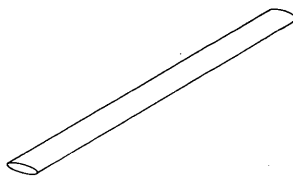

9900359 BLADE, BURNISHING, 2.75 IN LG

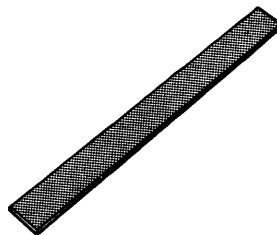

2108010 PADDLE, DISK CLEANING
2108474 HEAD CLEANING PADDLE

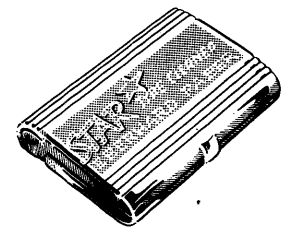

450528 TYPE CLEANER

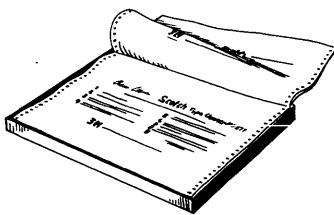

451529 TYPE CLEANER, SCOTCH

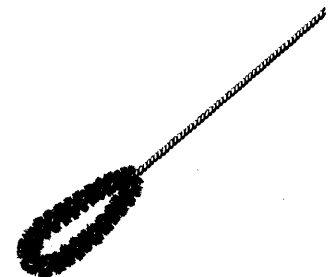

2200106 BRUSH, HEAD CLEANING
2314

Group 11

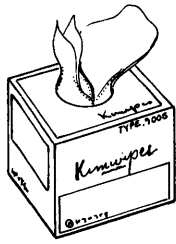

2162567 KIMWIPES
5 X 8-3/4 IN



2123106 KIMWIPES
15 X 17-5/8 IN

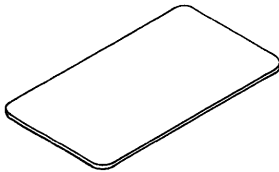

2200033 CLEANING TOOL, STRIP GUIDE

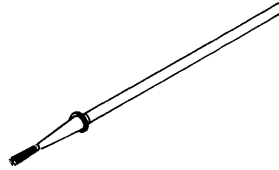

9900014 BRUSH, OIL

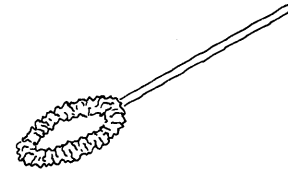

2245008 BRUSH, CAMELS HAIR



453536 BRUSH, TAPE OR TYPE-
CLEANING

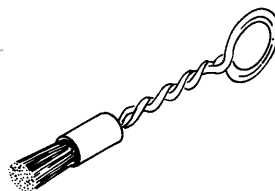

640255 BRUSH, PRINT HEAD

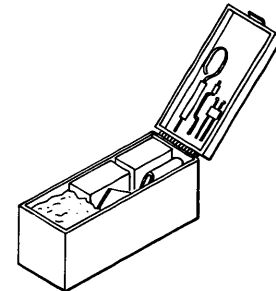

352465 KIT ASM, TAPE CLEANER
CONSISTING OF

352466 BOX, CLEANER

352561 DECAL, CLEANING
INSTRUCTION

352605 FELT PADS PACKAGE

352606 PAD HOLDER

556944 Q - TIPS

556945 BRUSH, CLEANER 2 1/2"
NYLON

1018992 BRUSH, TAPE CLEANING

2108930 CLOTH, LINT FREE 9 X 9

2507587 PROBE, 1/8" X 4 1/2"
NYLON

2513590 BRUSH, TAPE PATH
CLEANING

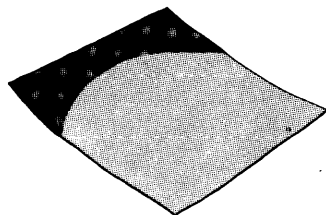

CLOTH

2108930 LINTFREE, PACK OF 10
*4098027 COLOURED, KG
*4691431 LINEN, KG

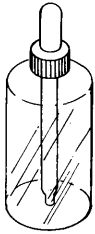

2108790 SYRINGE, WIPER LUBRICATING

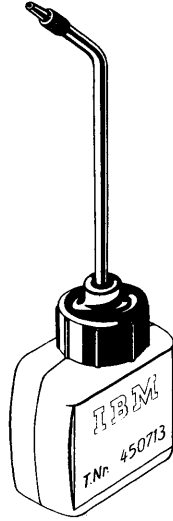

450713 OILER, HAND

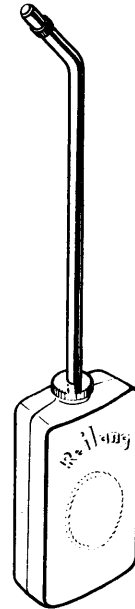

*489067 OILER, HAND, LONG TUBE

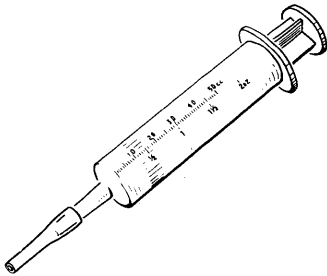

*4261085 OIL WITHDRAW TOOL, HYDRAULIC 1311

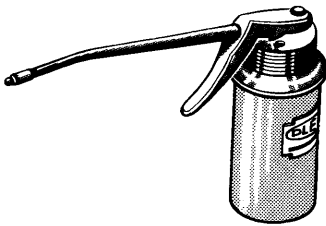

153778 OILER, HAND, 6 OZ, PISTOL

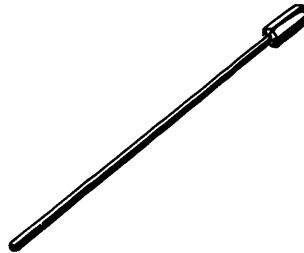

450443 EXTENSION OILER, FLEDBILE FOR 153778

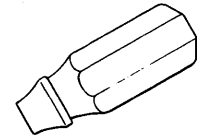

450014 NOZZLE, OILER FOR 153778



158645 GREASE GUN NOZZLE, GREASE GUN 9900271

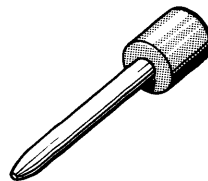

450813 NOZZLE, GREASE GUN 158645

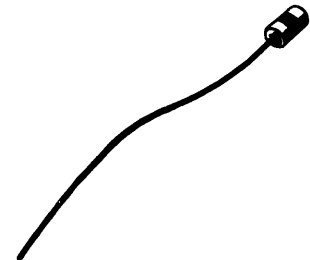

450566 EXTENSION, GREASE NOZZLE TIP FOR 158645



450787 NOZZLE, GREASE GUN FOR 158645

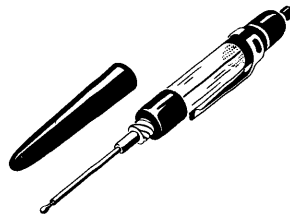

*4261101 OIL DROPPER

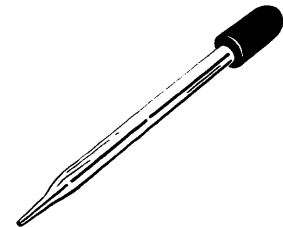

2108021 DROPPER, POLYETHYLENE WITH RUBBER BULB

Group 12

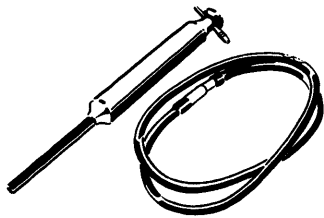

450686 FLUID PUMP, TRU-PLATE

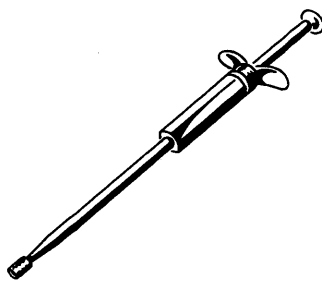

450640 OIL SYRINGE
158829 CAP, GUN, OIL

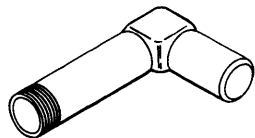

453186 COUPLER, 90°
FOR 158645

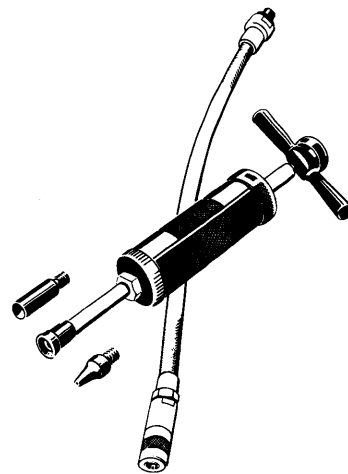

*489945 GREASE GUN

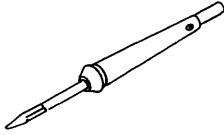

*489881 IRON, SOLDERING, 16W 200V
 *489882 IRON, SOLDERING, 16W
 *489883 TIP, REPLACEABLE

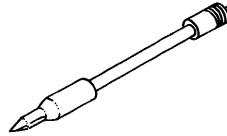

5392428 TIP, SOLDERING IRON,
 FOR 460816

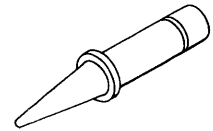

461589 TIP, SOLDERING,
 FOR 462590



450657 SOLDERING, GUN, ELECTRIC

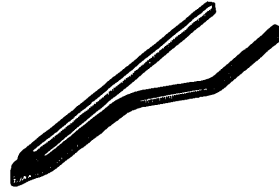

450717 TIP, ELECTRIC SOLDERING
 GUN, FOR 450657

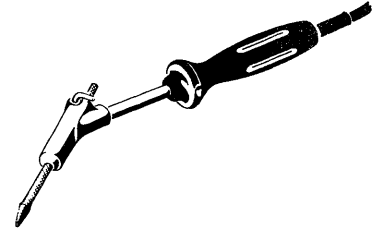

SOLDERING IRON
 *490581 220V 120W

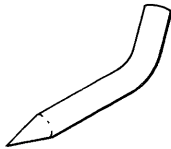

454335 TIP, BENT, ROUND SOLDERING
 FOR 454333

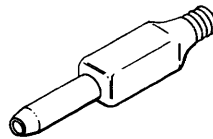

454333 ELEMENT, SOLDERING, 37W,
 FOR 454332 HANDLE

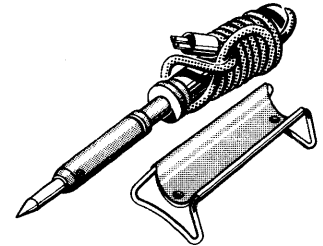

55864 SOLDERING IRON, ELECTRIC,
 125W, 110V

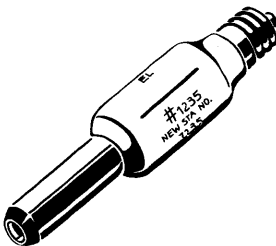

HEATING ELEMENT
 461393 23,5W 110V, FOR 454332

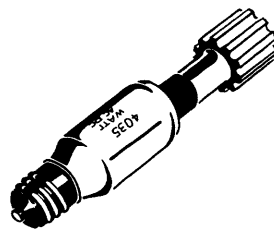



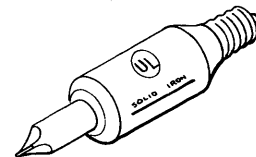

460194 HEATING ELEMENT
 110V, FOR 454332

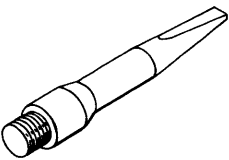
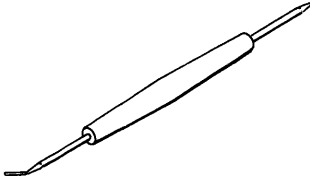
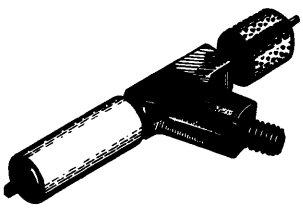
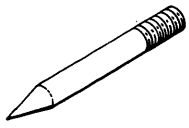
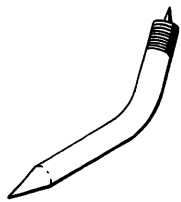
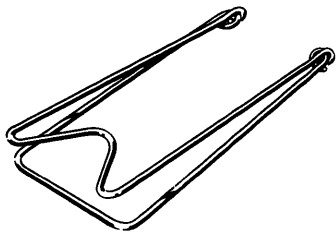
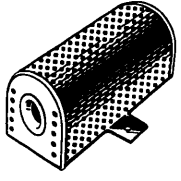

450314 HEATING ELEMENT
 WITH TIP 37,5W 110V
 FOR 454332

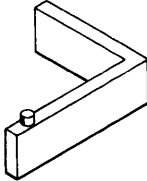
Group 13

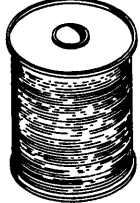
 <p>9900016 TIP, LARGE, SOLDER, FOR 454322</p>	 <p>5230032 SOLDERING AID</p>	 <p>451111 TIP, ELECTRIC SOLDERING IRON 451112 SOLDERING IRON CAP 451113 PLUNGER, TIP 451114 INSULATOR, TIP</p>
 <p>454334 TIP, STRAIGHT, ROUND SOLDER</p>	 <p>454335 TIP, BEND, ROUND, SOLDER</p>	
		 <p>*489976 SOLDERING IRON STAND</p>
 <p>512892 CAGE, HEAT, SOLDERING IRON</p>	 <p>461394 HEAT SEAL TIP/METERING</p>	 <p>9900104 TYPE SOLDERING FIXTURE</p>
 <p>4055 FLUX, SOLDERING, PASTE 461599 FLUX, CARD REPAIR</p>	 <p>771448 SOLDER, .028 ROSIN CORE, 3 FT 452393 SOLDER, .031 ROSIN CORE, 1 LB ROLL 2102025 SOLDER, LEAD TINALLOY, WW ROSIN, .062 DIA</p>	

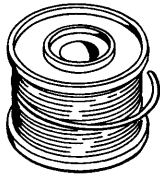

5151439 WICK, SOLDER

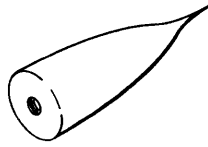

5392430 MINITIP, SOLDERING IRON FOR 5392431

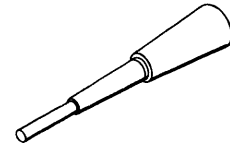

5392434 CORD IRON

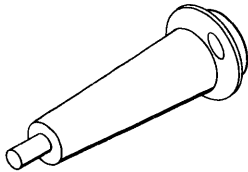

5392433 HANDLE, IRON, FOR 5392434

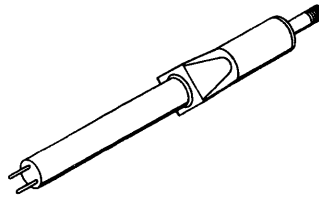

5392431 CARTRIDGE, HEAT, 25W
5392432 CARTRIDGE, HEAT, 40W FOR 5392433

*Application restricted.
Use only according to local safety regulations.
(Heating Element is not grounded!)

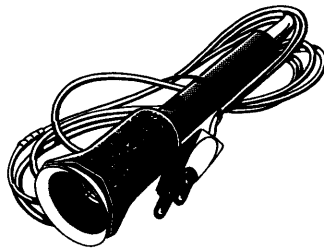

454332 HANDLE AND CORD SET, SOLDERING IRON

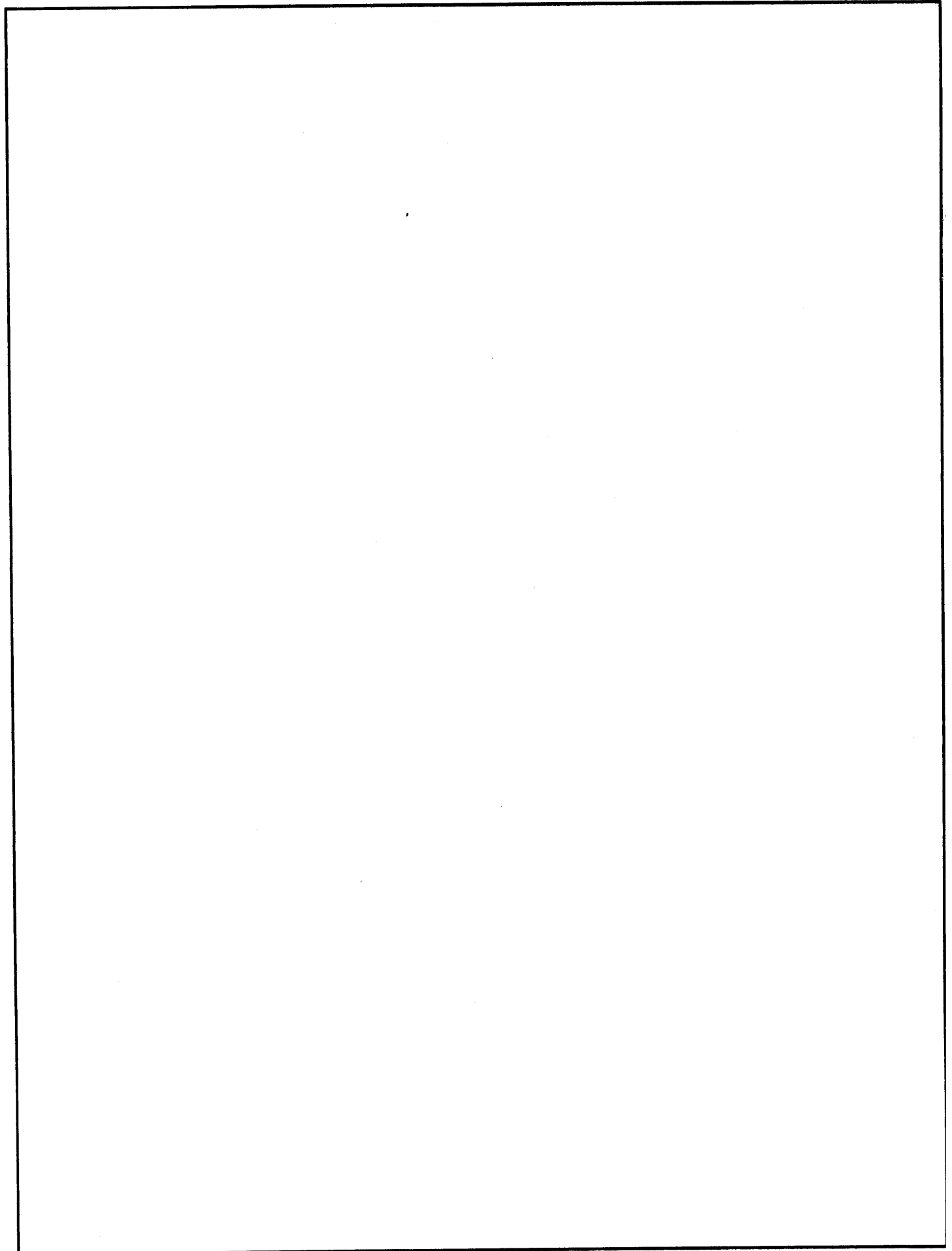

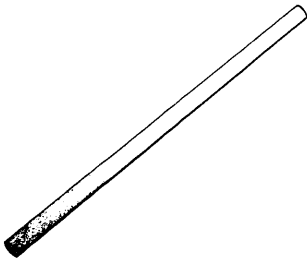

450567 BLADE, BURNISHING,
SILVER CONTACT

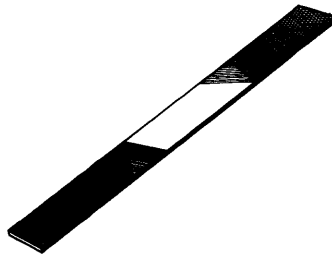

*489076 FILE, RELAY CONTACT

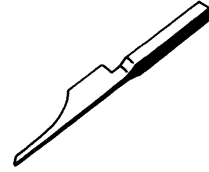

451907 PM RELAY TOOL

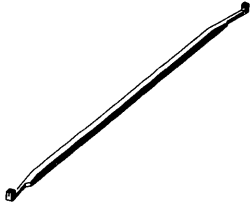

450660 BENDING TOOL,
RELAY CONTACT



*489150 ADJUSTING TOOL,
CONTACT SPRING

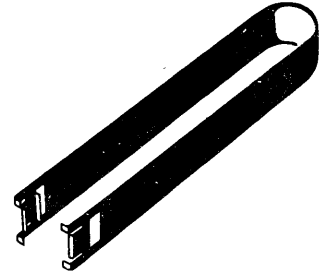

454065 PULLER, RELAY



450458 EXTENSION, TEST,
WIRE CONT RELAY

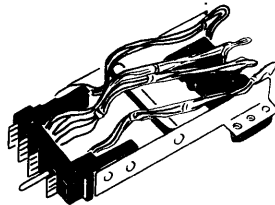

ADAPTER ASSEMBLY, RELAY TEST,
460987 4 POINT
460988 6 POINT
450989 12 POINT

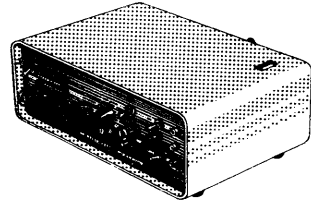

9900175 DYNAMIC RELAY TESTER
9900181 MERCURY RELAY

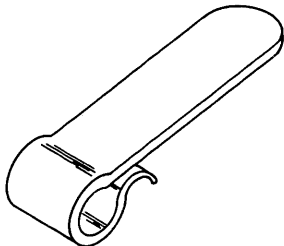

9900206 INSERTION TOOL,
WIRE CONTACT RELAY

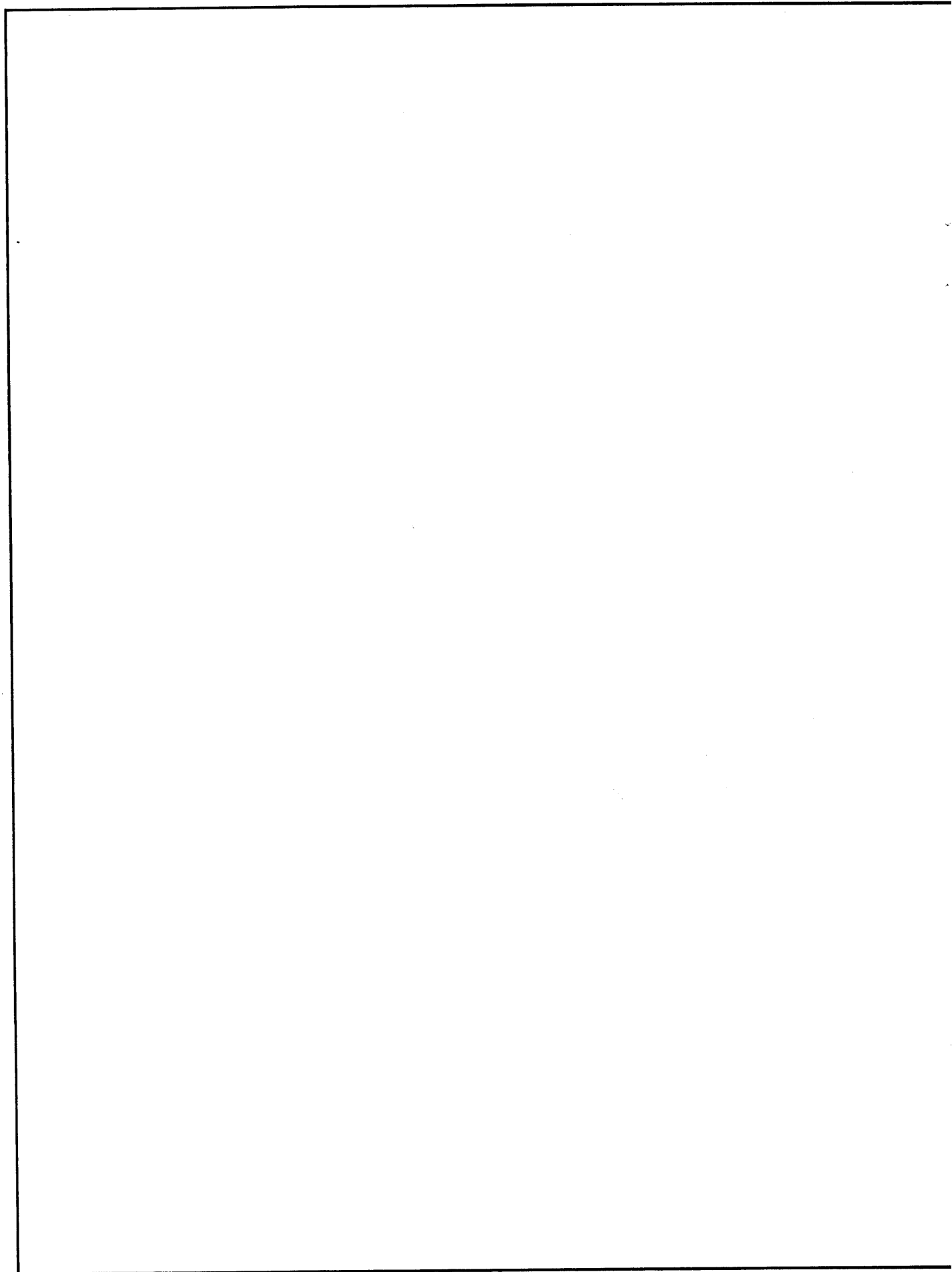

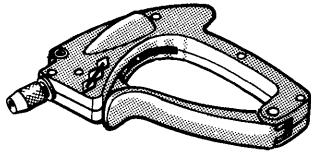

451572 WRAPPED WIRE TOOL, HAND

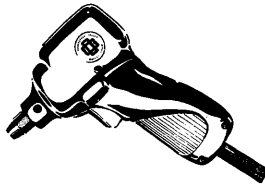

453512 WRAPPED WIRE TOOL, ELECTRIC, 110V

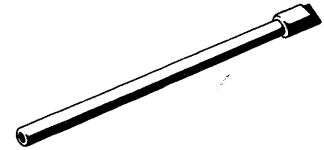

BIT, WIRE WRAP

- 461011 SIZE 20
- 461010 SIZE 22
- 461235 SIZE 24
- 461063 SIZE 26



SLEEVE, WIRE WRAP

- 461016 20
- 461015 22-24
- 461014 26

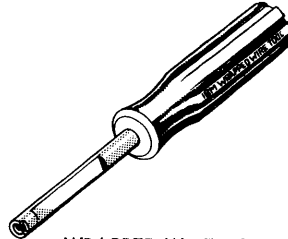

WRAPPED WIRE TOOL

- 451140 20-22
- 451142 24-26

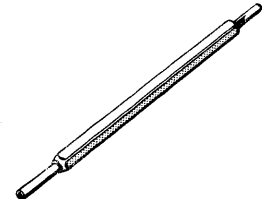

451573 WIRE UNWRAP TOOL, RH AND LH

- 452384 TIP, UNWRAP, RH
- 452385 TIP, UNWRAP, LH

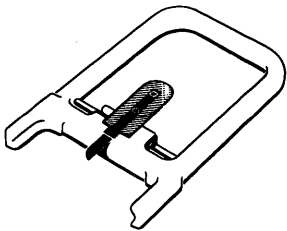

451030 PULLER, SMS CARD, SINGLE

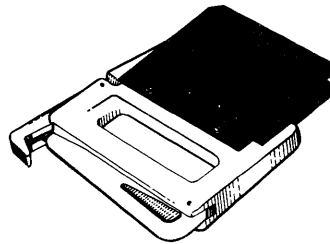

461110 PULLER, SMS CARD, DOUBLE

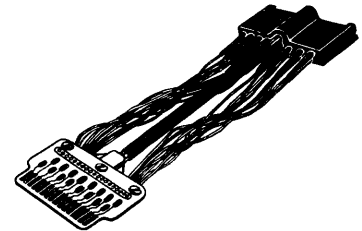

451075 EXTENDER, CARD AND CABLE, SMS

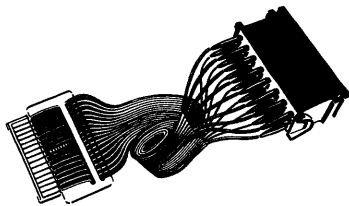

452399 CARD, EXTENDER, 36 IN. FLAT CABLE

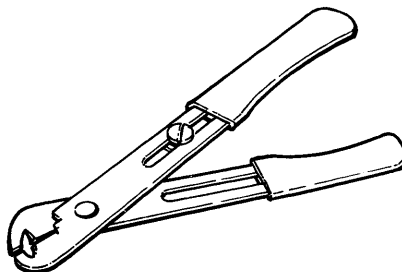

450694 STRIPPER, WIRE

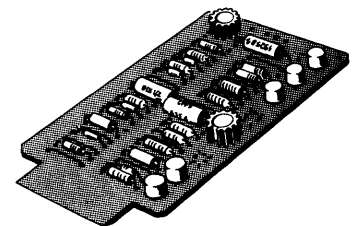

370616 AMPLIFIER CARD, MARG. PS, 60 HZ

- 370823 OSCILLATOR CARD 1,5 MC
- 372561 VARIABLE OSCILLATOR CARD
- 370421 YCC CARD, ASYMMETRY ADJUST

374900 ENH CARD, ASYMMETRY ADJUST

- 2108889 CE CARD HEAD SELECT 1311
- 2108771 CE CARD 20 X AMPLIFIER
- 2108770 CE CARD CLIPPER 1311
- 2108594 CE CARD 10 X AMPLIFIER AND CLIPPER 1311
- 2108591 CE CARD CRYSTAL OSCILLATOR 1311



451271 TEMPLATE KIT, SINGLE CARD, SMS CAP CODE

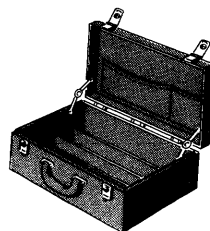

*4261062 CASE, SMS CARD

Group 15

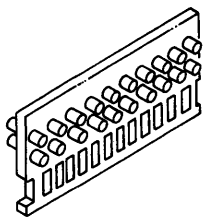

2258530 PLUG WRAP
1506

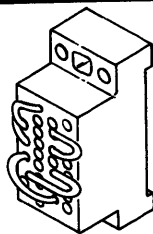

5808354 EXTENDER, CARD
1800

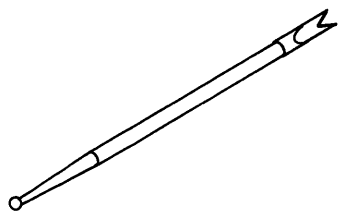

461262 SMS BACK PANEL
PROBE, NYLON

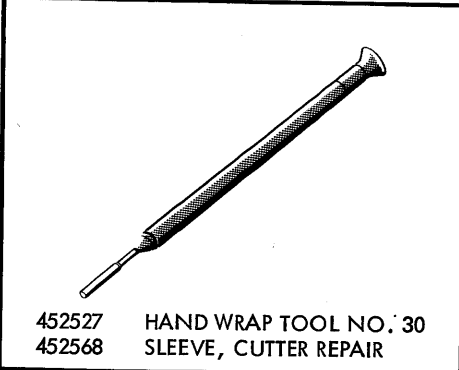

452527 HAND WRAP TOOL NO. 30
452568 SLEEVE, CUTTER REPAIR

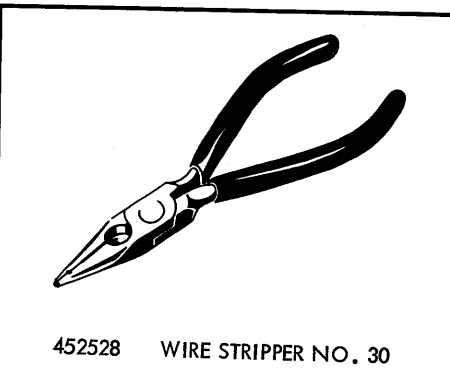

452528 WIRE STRIPPER NO. 30

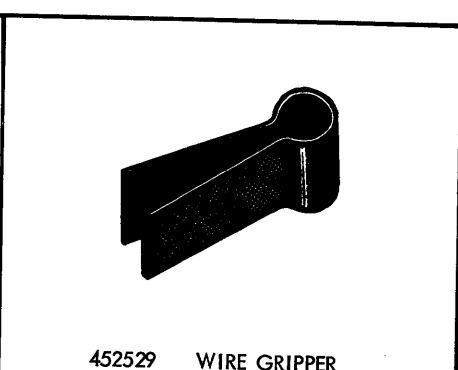

452529 WIRE GRIPPER



452561 X-ACTO KNIFE

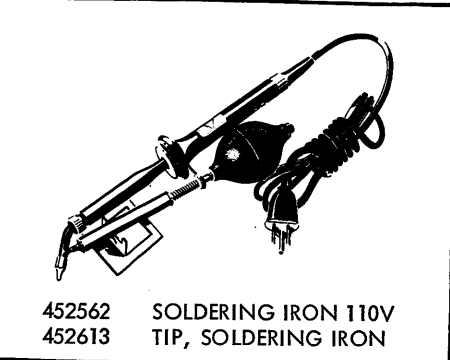

452562 SOLDERING IRON 110V
452613 TIP, SOLDERING IRON

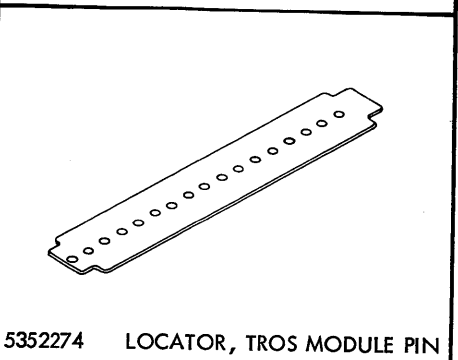

5352274 LOCATOR, TROS MODULE PIN

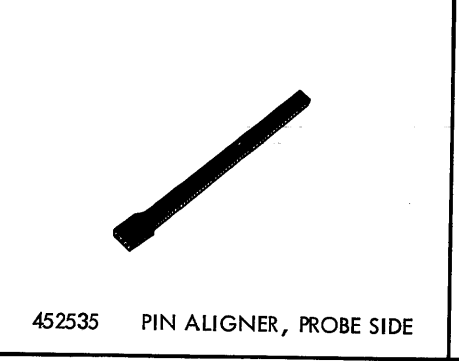

452535 PIN ALIGNER, PROBE SIDE

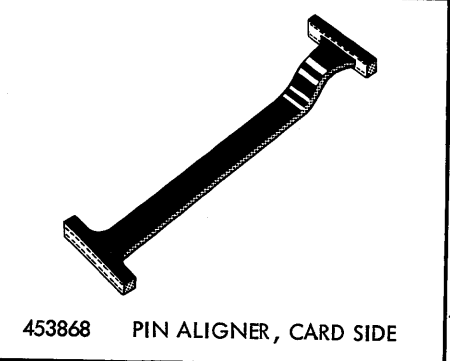

453868 PIN ALIGNER, CARD SIDE

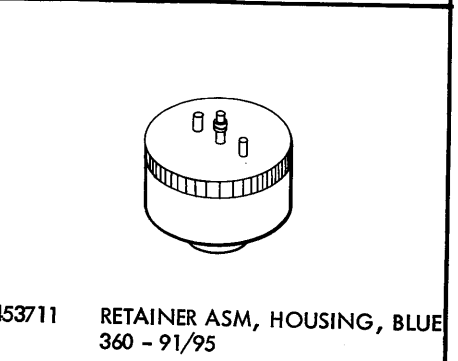

453711 RETAINER ASM, HOUSING, BLUE
360 - 91/95

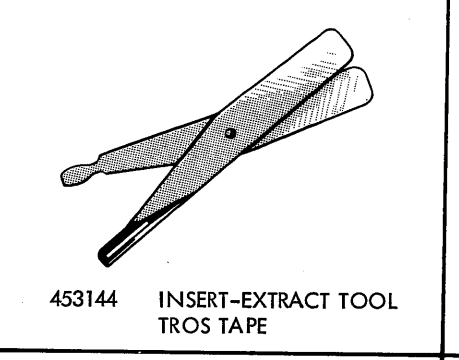

453144 INSERT-EXTRACT TOOL
TROS TAPE

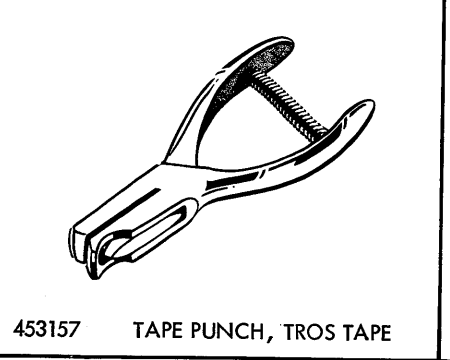

453157 TAPE PUNCH, TROS TAPE

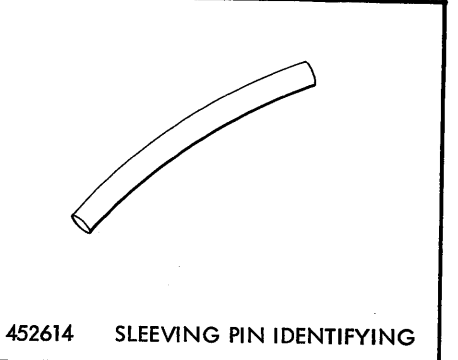

452614 SLEEVING PIN IDENTIFYING

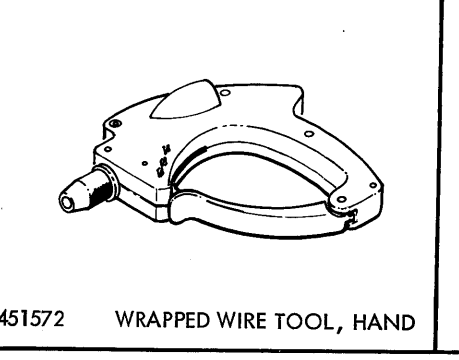

451572 WRAPPED WIRE TOOL, HAND

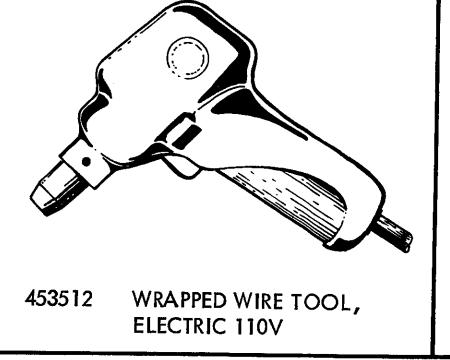

453512 WRAPPED WIRE TOOL,
ELECTRIC 110V

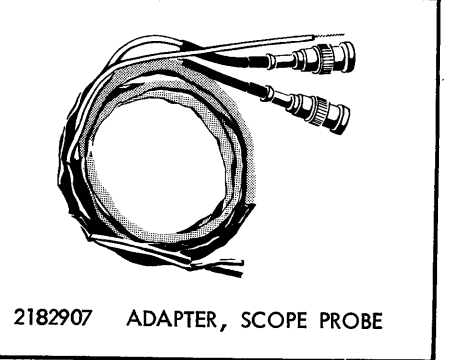

2182907 ADAPTER, SCOPE PROBE

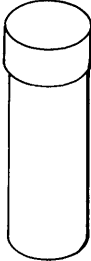
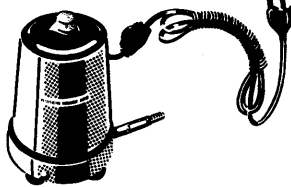
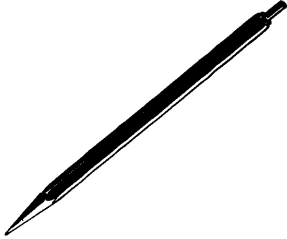
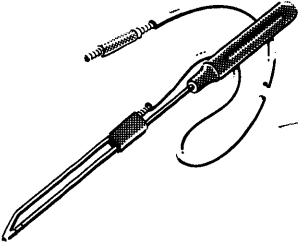
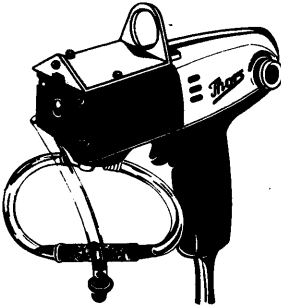
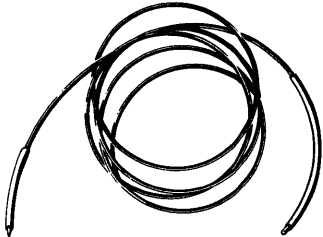
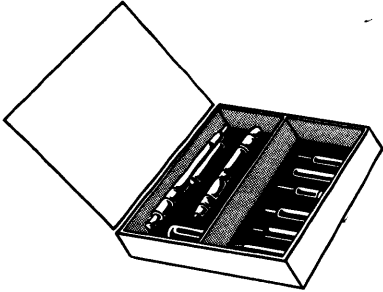
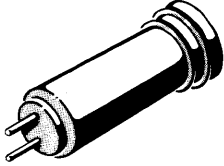
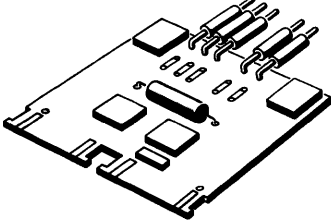
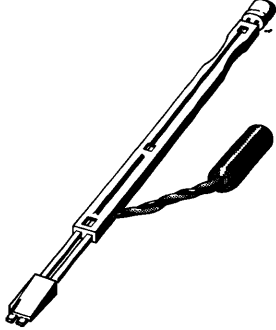
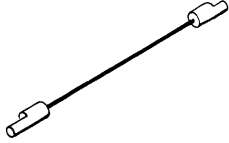
 <p>453758 CONTAINER ASM, SOLDER PREFORMS 360 - 91/95</p>	 <p>453091 VACUUM PUMP 110 V 452564 CHIP COLLECTOR ASM</p>	 <p>453101 PROBE, PLASTIC</p>
 <p>452626 DELETE TOOL, 7 IN 178 MM</p>	 <p>453134 POWER DELETE HANDLE 453063 VACUUM PUMP ASM 453085 SHAFT REDUCTION GEAR 453588 ADAPTER PLATE 453064 FILTER ASM 453066 RING 453067 SPONGE 453084 MOTOR ASM 453766 RECTIFIER 2176205 SWITCH</p>	 <p>453130 EXTENSION LEAD, CONTINUITY INDICATOR</p>
	<p>453428 PIN REPLACEMENT KIT MST-SLT 453037* DRILL NO. 56 1.20 MM 450262 DRILL NO. 53 1.50 MM 451148 BOX PLASTIC 452616 IMPACT TOOL 453390 EXTENSION 453443* VIAL REPLACEMENT PIN 0.515 D 453444 VIAL REPLACEMENT PIN 0.515 S 453773* REAMER 0.050 IN 2108019 PIN VISE 452617 EMBOSING BIT 452618 SHORT DRIVER BIT 453112 LONG DRIVER BIT 453135 DRIFT DRIVER BIT 453774 DRIVER REPLACEMENT PIN 453778* LOCATING BLOCK * THESE TOOLS ARE FOR MST DOUBLE BOARDS ONLY</p>	 <p>453612 ADAPTER ASM SYNC POINT SYS 360</p>
<p>453428 PIN REPLACEMENT KIT MST-SLT 453037* DRILL NO. 56 1.20 MM 450262 DRILL NO. 53 1.50 MM 451148 BOX PLASTIC 452616 IMPACT TOOL 453390 EXTENSION 453443* VIAL REPLACEMENT PIN 0.515 D 453444 VIAL REPLACEMENT PIN 0.515 S 453773* REAMER 0.050 IN 2108019 PIN VISE 452617 EMBOSING BIT 452618 SHORT DRIVER BIT 453112 LONG DRIVER BIT 453135 DRIFT DRIVER BIT 453774 DRIVER REPLACEMENT PIN 453778* LOCATING BLOCK * THESE TOOLS ARE FOR MST DOUBLE BOARDS ONLY</p>	 <p>5800613 CARD, BIT ALIGN, 50 5888962 AI FILTER MEDIUM SPEED SYS 7 5888972 AI FILTER LOW SPEED SYS 7 5888976 DO TERMINATOR CARD SYS 7 2703540 DI TERMINATOR CARD SYS 7 5888970 REFERENCE VOLTAGE ELEMENT SYS 7</p>	 <p>453888 PROBE TIP ENCAPSULATED MST-2-4</p>
<p>453428 PIN REPLACEMENT KIT MST-SLT 453037* DRILL NO. 56 1.20 MM 450262 DRILL NO. 53 1.50 MM 451148 BOX PLASTIC 452616 IMPACT TOOL 453390 EXTENSION 453443* VIAL REPLACEMENT PIN 0.515 D 453444 VIAL REPLACEMENT PIN 0.515 S 453773* REAMER 0.050 IN 2108019 PIN VISE 452617 EMBOSING BIT 452618 SHORT DRIVER BIT 453112 LONG DRIVER BIT 453135 DRIFT DRIVER BIT 453774 DRIVER REPLACEMENT PIN 453778* LOCATING BLOCK * THESE TOOLS ARE FOR MST DOUBLE BOARDS ONLY</p>	<p>5800613 CARD, BIT ALIGN, 50 5888962 AI FILTER MEDIUM SPEED SYS 7 5888972 AI FILTER LOW SPEED SYS 7 5888976 DO TERMINATOR CARD SYS 7 2703540 DI TERMINATOR CARD SYS 7 5888970 REFERENCE VOLTAGE ELEMENT SYS 7</p>	 <p>829117 JUMPER ASM, SLT 6 IN 892118 JUMPER ASM, SLT 18 IN 829119 JUMPER ASM, 2520 - B</p>

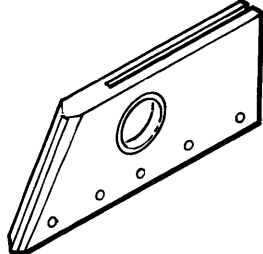
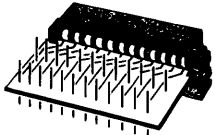
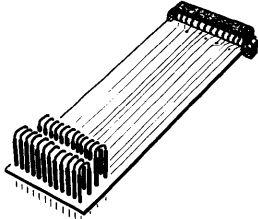
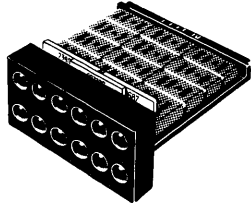
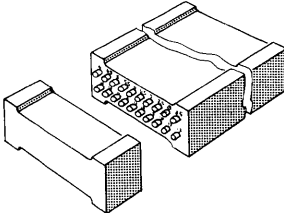
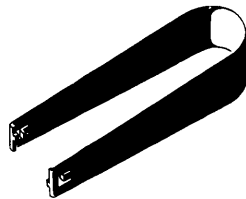
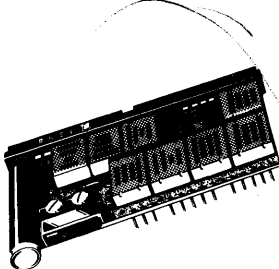
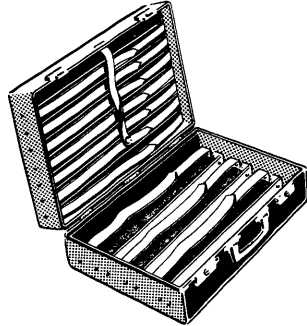
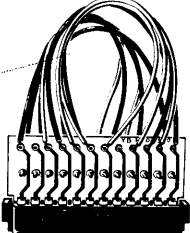
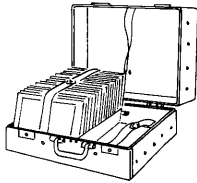
 <p>2360383 CABLE FOLDING TOOL FLAT POWER DIST.</p>	 <p>452530 CARD OFF - SET</p>	 <p>452554 CARD EXTENDER, 6 PACK 452608 JUMPER 1 IN 452655 JUMPER, 4 IN. 102 MM</p>
 <p>5803976 DISPLAY CARD, 12 POS STAGE 1 5803975 DISPLAY CARD, 12 POS STAGE 2</p>	 <p>453106 WIRE CADDY, PRE CUT WIRES 815094 WIRE COMPLEMENT, LENGTH 4.0 IN 815095 WIRE COMPLEMENT, LENGTH 4.5 IN 815096 WIRE COMPLEMENT, LENGTH 5.0 IN 815097 WIRE COMPLEMENT, LENGTH 5.5 IN 815098 WIRE COMPLEMENT, LENGTH 6.0 IN 815099 WIRE COMPLEMENT, LENGTH 6.5 IN 815100 WIRE COMPLEMENT, LENGTH 7.0 IN 815101 WIRE COMPLEMENT, LENGTH 7.5 IN 815102 WIRE COMPLEMENT, LENGTH 8.0 IN 815103 WIRE COMPLEMENT, LENGTH 8.5 IN 815104 WIRE COMPLEMENT, LENGTH 9.0 IN 815105 WIRE COMPLEMENT, LENGTH 10.0 IN 815106 WIRE COMPLEMENT, LENGTH 11.0 IN 815107 WIRE COMPLEMENT, LENGTH 12.0 IN 815108 WIRE COMPLEMENT, LENGTH 13.0 IN 815109 WIRE COMPLEMENT, LENGTH 14.0 IN 815110 WIRE COMPLEMENT, LENGTH 15.0 IN 815111 WIRE COMPLEMENT, LENGTH 16.0 IN 815112 WIRE COMPLEMENT, LENGTH 17.0 IN 815113 WIRE COMPLEMENT, LENGTH 17.0 IN BLUE - WHITE</p>	 <p>2108860 STORAGE JUMPER REMOVAL TOOL</p>
 <p>375277 INDICATOR LATCH CARD- SMS 1143198 LAMP, FOR 375 277 453618 ADAPTER, SMS BACK PANEL 5801067 INDICATOR LATCH, SLT FAST LAMP, INDICATOR, FOR 5801358 5851882 INDICATOR LATCH MST- 1 5353889 LAMP FOR 5851882</p>	<p>* 4261114 CASE, SLT CARDS 8027615 BOX, SLT CARD, 1 HI 6 8027616 BOX, SLT CARD, 2 HI 6 8027617 BOX, SLT CARD, 1 HI 12 8027618 BOX, SLT CARD, 2 HI 12 8027619 BOX, SLT CARD, 3 HI 12</p>	
 <p>2182906 JUMPER, CORE STORAGE ADJUST</p>	<p>* 4261147 CASE, MST CARDS</p>	

Group 16

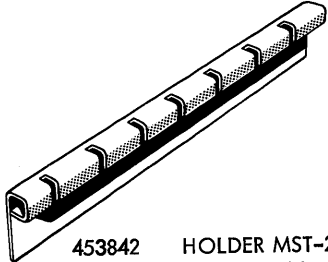
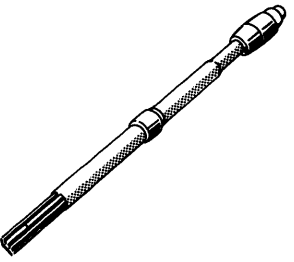
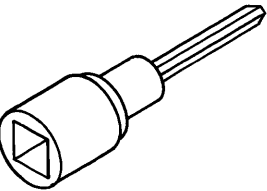
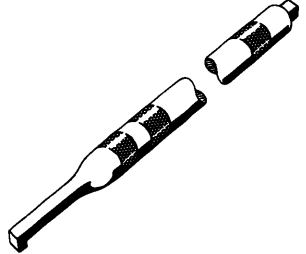
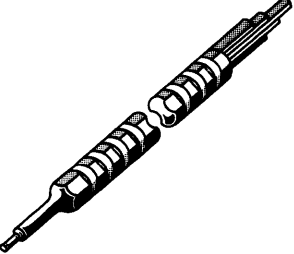
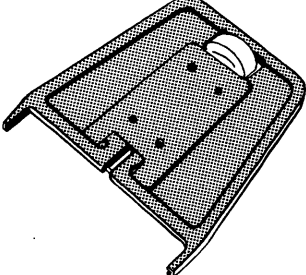
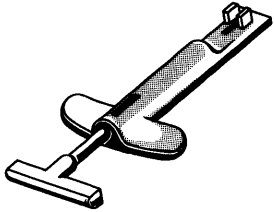
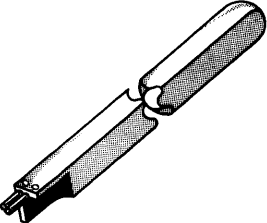
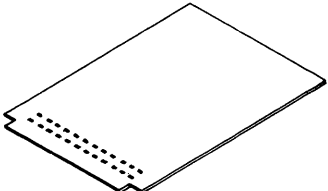
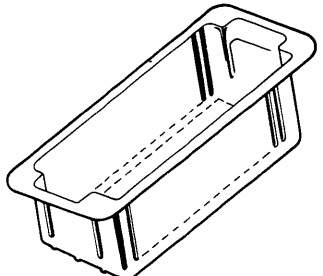
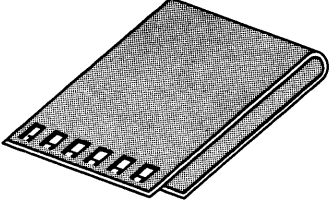
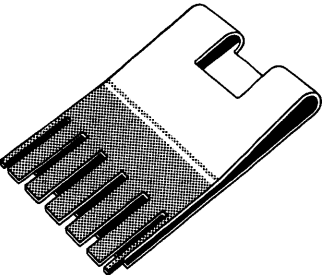
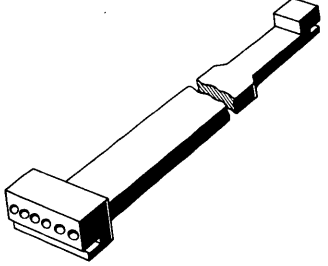
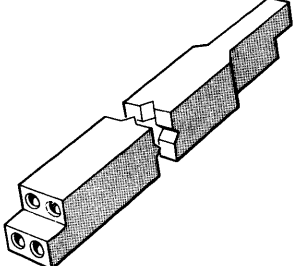
 453842 HOLDER MST-2-4 9 POSITION 453844 HOLDER MST-2-4 12 POSITION	 453904 HOUSING MST 2-4 INSERT-EXTRACT	 MST BOARD REMOVAL 453397 1/4" DR-ALLEN
 453140 INSERT-EXTRACT TOOL ASLT MSTX	 453470 INSERT-EXTRACT TOOL MID-AIR MST-2 MST-4	 453787 CARD PULLER 4 WIDE MST-1
 453452 TUNING FORK EXTRACT TOOL MST-4	 453889 TUNING FORK SEATING TOOL MST-4	 8218343 OSCILLATOR, VARIABLE FREQUENCY 3803
 453757 CARD CADDY ASLT MSTX 453769 CARD CADDY MST-2-4	 453405 DELAY BLOCK EXTRACT TOOL ASLT MSTX	 453447 GANG-CLIP MST-2 LONG T-BAR 453879 GANG-CLIP MST-2 SHORT T-BAR 453477 GANG-CLIP MST-4 LONG T-BAR
 453777 ALIGNER GROUND RAIL MST-2-4	 453133 ALIGNER GROUND RAKE ASLT MSTX	453447 GANG-CLIP MST-2 LONG T-BAR 453879 GANG-CLIP MST-2 SHORT T-BAR 453477 GANG-CLIP MST-4 LONG T-BAR

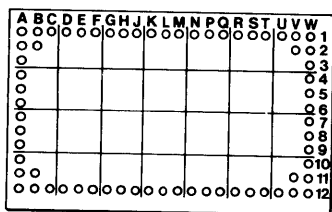

- 2360328 MASK CARD PROBING
1W2H MST-1-2
- 2360329 MASK CARD PROBING
2W2H MST-1-2
- 2360330 MASK CARD PROBING
4W2H MST-1-2
- 2360331 MASK CARD PROBING
2W3H MST-4
- 2360332 MASK CARD PROBING
4W3H MST-4

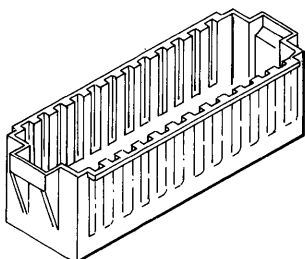

453757 CARD CADDY
360 - 91/95



453163 PROBE TIP 6-32 SLT MST
1-2 SGL

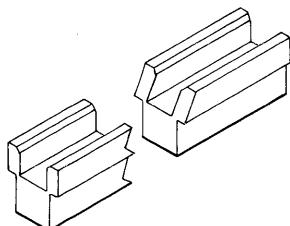

453772 ADAPTER, 3H1W

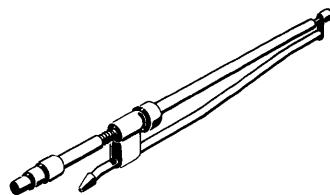

- 453059 DELETE FERRULE SLT MST-1
- 74530 SET SCREW
- 452572 SHALLOW DELETE CUTTER
- 453061 RETAINING CLIP
- 453944 RETAINING RING

- 453461 DELETE FERRULE LONG
SHALLOW ASLT MST-2-4-X

- 74530 SET SCREW
- 452572 SHALLOW DELETE CUTTER
- 453944 RETAINING RING

- 453780 DELETE FERRULE DEEP
MST-2 DBL

- 74530 SET SCREW
- 453808 DEEP DELETE CUTTER
- 453944 RETAINING RING

- 453942 DELETE FERRULE DEEP MST-4

- 74530 SET SCREW
- 453808 DEEP DELETE CUTTER
- 453944 RETAINING RING

- 461556 DELETE FERRULE DEEP
ASLT MSTX

- 74530 SET SCREW
- 453061 RETAINING CLIP
- 453944 RETAINING RING
- 461545 DEEP DELETE CUTTER

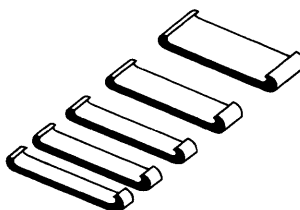

453437 AIR BAFFLE SET ASLT MSTX



453954 MALE COAX FEMALE 6-32
ADAPTER

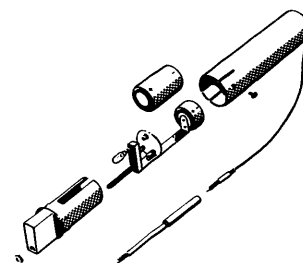

453587 CONTINUITY CHECKER
453119 1.35 V BATTERY
453120 2.80 V BATTERY
5353889 INDICATOR BULB

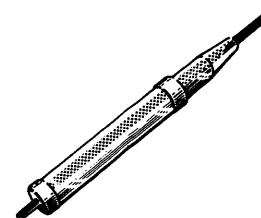

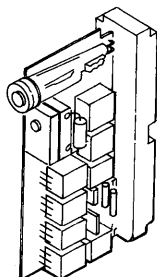

2360333 PROBE CARD MASK

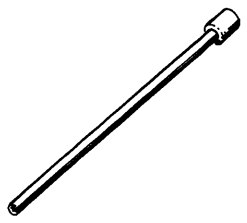

5808897 INDICATOR LATCH CARD,
SLT 100, 2791
372277 INDICATOR LATCH CARD,
SMS

Group 16

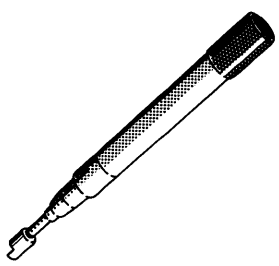
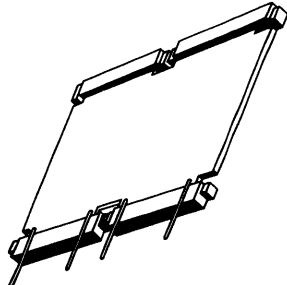
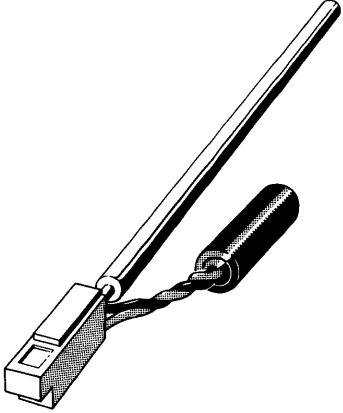
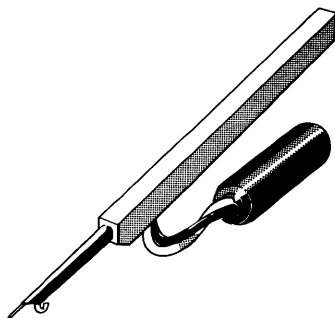
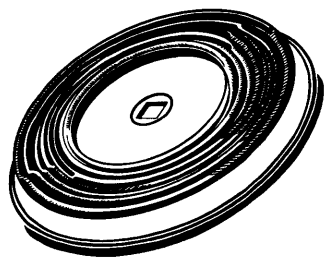
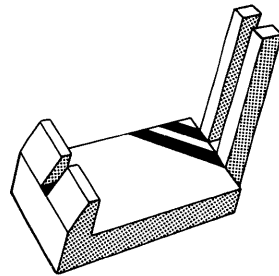
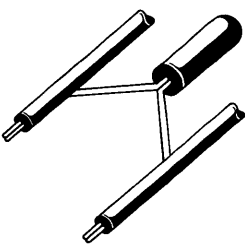
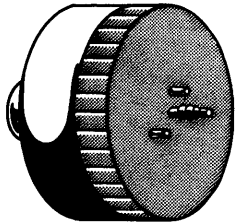
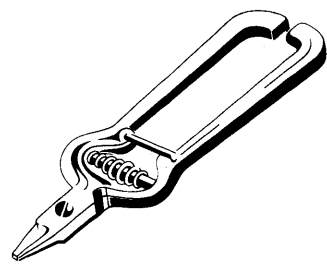
 <p>9263122 BIT WIRE WRAP SIZE 30 SLT MST - 1 MST - 2 SGL</p>	 <p>9328353 SLEEVE WIRE WRAP 30 SLT MST - 1 MST - 2 SGL</p>	 <p>2360355 WIRE WRAP EXTENSION ASM MST - 2</p>
 <p>5853341 EXTENDER ASM OFFSET MST-4 453454 EXTENDER ASM MST-4 453740 EXTENDER ASLT MSTX</p>	 <p>453834 PROBE TIP ASM FEMALE ASLT MSTX</p>	 <p>453836 PROBE TIP ASM MALE ASLT MSTX</p>
<p>5853341 EXTENDER ASM OFFSET MST-4 453454 EXTENDER ASM MST-4 453740 EXTENDER ASLT MSTX</p>	 <p>815905 WIRE REEL ASM 275 FEET NO. 30 YELLOW SLT MST-1-2 815906 WIRE REEL ASM 275 FEET NO. 30 BLUE SLT 815907 WIRE REEL ASM 275 FEET NO. 30 BLUE-WHITE SLT MST-1-2</p>	
 <p>453770 EXTENDER CLAMP ASLT MSTX</p>	<p>815905 WIRE REEL ASM 275 FEET NO. 30 YELLOW SLT MST-1-2 815906 WIRE REEL ASM 275 FEET NO. 30 BLUE SLT 815907 WIRE REEL ASM 275 FEET NO. 30 BLUE-WHITE SLT MST-1-2</p>	<p>815905 WIRE REEL ASM 275 FEET NO. 30 YELLOW SLT MST-1-2 815906 WIRE REEL ASM 275 FEET NO. 30 BLUE SLT 815907 WIRE REEL ASM 275 FEET NO. 30 BLUE-WHITE SLT MST-1-2</p>
 <p>453446 PROBE TIP MSTX</p>	 <p>453721 RESTRAINER HOUSING ASTMSTX YELLOW 453722 RETAINER HOUSING ASLT MSTX BLACK</p>	 <p>453739 CUTTER GROUND RAKE ASLT MSTX</p>

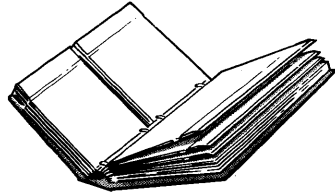

- 453903 90 OHM WIRE CADDY
- 453738 90 OHM TERMINATER QTY 20
- 453917 HOUSING QTY 50
- 2360078 WIRE CADDY 2.5 IN 63.5 MM 90 OHM TRI-LEAD QTY 8
- 2360000 WIRE CADDY 3.0 IN 76.2 MM 90 OHM TRI-LEAD QTY 8
- 2360001 WIRE CADDY 3.5 IN 88.9 MM 90 OHM TRI-LEAD QTY 8
- 2360002 WIRE CADDY 4.0 IN 101.6 MM 90 OHM TRI-LEAD QTY 8
- 2360003 WIRE CADDY 4.5 IN 114.3 MM 90 OHM TRI-LEAD QTY 8
- 2360004 WIRE CADDY 5.0 IN 127.0 MM 90 OHM TRI-LEAD QTY 8
- 2360005 WIRE CADDY 5.5 IN 139.7 MM 90 OHM TRI-LEAD QTY 8
- 2360006 WIRE CADDY 6.0 IN 152.4 MM 90 OHM TRI-LEAD QTY 8
- 2360007 WIRE CADDY 7.0 IN 177.8 MM 90 OHM TRI-LEAD QTY 8
- 2360008 WIRE CADDY 8.0 IN 203.2 MM 90 OHM TRI-LEAD QTY 8
- 2360009 WIRE CADDY 9.0 IN 228.6 MM 90 OHM TRI-LEAD QTY 8
- 2360010 WIRE CADDY 10.0 IN 254.0 MM 90 OHM TRI-LEAD QTY 8
- 2360011 WIRE CADDY 11.0 IN 279.4 MM 90 OHM TRI-LEAD QTY 8
- 2360012 WIRE CADDY 12.0 IN 304.8 MM 90 OHM TRI-LEAD QTY 8
- 2360013 WIRE CADDY 13.0 IN 330.2 MM 90 OHM TRI-LEAD QTY 8
- 2360014 WIRE CADDY 14.0 IN 335.6 MM 90 OHM TRI-LEAD QTY 8
- 2360015 WIRE CADDY 15.0 IN 381.0 MM 90 OHM TRI-LEAD QTY 8
- 2360016 WIRE CADDY 16.0 IN 406.4 MM 90 OHM TRI-LEAD QTY 8
- 2360017 WIRE CADDY 17.0 IN 431.8 MM 90 OHM TRI-LEAD QTY 12
- 2360018 WIRE CADDY 18.0 IN 457.2 MM 90 OHM TRI-LEAD QTY 12
- 2360019 WIRE CADDY 19.0 IN 482.6 MM 90 OHM TRI-LEAD QTY 12
- 2360020 WIRE CADDY 20.0 IN 508.0 MM 90 OHM TRI-LEAD QTY 12
- 2360370 MID-AIR SPLICE QTY 4

- 453900 50 OHM WIRE CADDY
- 453737 50 OHM TERMINATER QTY 10
- 453917 HOUSING QTY 50
- 453918 WIRE CADDY 3.0 IN 76.2 MM 50 OHM TRI-LEAD QTY 8
- 453919 WIRE CADDY 3.5 IN 88.9 MM 50 OHM TRI-LEAD QTY 8
- 453920 WIRE CADDY 4.0 IN 101.6 MM 50 OHM TRI-LEAD QTY 8
- 453921 WIRE CADDY 4.5 IN 114.3 MM 50 OHM TRI-LEAD QTY 8
- 453922 WIRE CADDY 5.0 IN 127.0 MM 50 OHM TRI-LEAD QTY 8
- 453923 WIRE CADDY 5.5 IN 139.7 MM 50 OHM TRI-LEAD QTY 8
- 453924 WIRE CADDY 6.0 IN 152.4 MM 50 OHM TRI-LEAD QTY 8
- 453925 WIRE CADDY 7.0 IN 177.8 MM 50 OHM TRI-LEAD QTY 8
- 453926 WIRE CADDY 8.0 IN 203.2 MM 50 OHM TRI-LEAD QTY 8
- 453927 WIRE CADDY 9.0 IN 228.6 MM 50 OHM TRI-LEAD QTY 8
- 453928 WIRE CADDY 10.0 IN 254.0 MM 50 OHM TRI-LEAD QTY 8
- 453929 WIRE CADDY 11.0 IN 279.4 MM 50 OHM TRI-LEAD QTY 8
- 453930 WIRE CADDY 12.0 IN 304.8 MM 50 OHM TRI-LEAD QTY 8
- 453931 WIRE CADDY 13.0 IN 330.2 MM 50 OHM TRI-LEAD QTY 8
- 453932 WIRE CADDY 14.0 IN 355.6 MM 50 OHM TRI-LEAD QTY 8
- 453933 WIRE CADDY 15.0 IN 381.0 MM 50 OHM TRI-LEAD QTY 8
- 453934 WIRE CADDY 16.0 IN 404.6 MM 50 OHM TRI-LEAD QTY 8
- 453935 WIRE CADDY 17.0 IN 431.8 MM 50 OHM TRI-LEAD QTY 12
- 453936 WIRE CADDY 18.0 IN 457.2 MM 50 OHM TRI-LEAD QTY 12
- 453937 WIRE CADDY 19.0 IN 482.6 MM 50 OHM TRI-LEAD QTY 12
- 453938 WIRE CADDY 20.0 IN 508.0 MM 50 OHM TRI-LEAD QTY 12
- 2360089 WIRE CADDY 2.5 IN 63.5 MM 50 OHM TRI-LEAD QTY 8
- 2360370 MID-AIR SPLICE QTY 4

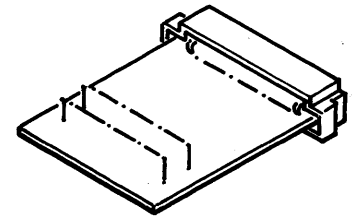

5998763 CABLE EXTENDER

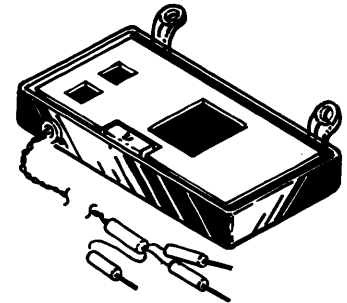

** 2728225 CARD ASM, LATCH, MST 2 - 4

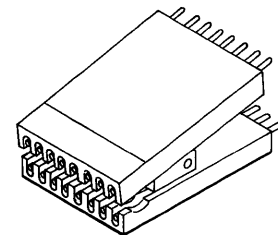

2518318 TEST CLIP, INTEGRATED CIRCUIT 3410

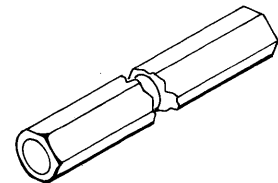

453712 HEX TIP, GANG BRACKET 360 - 91/95

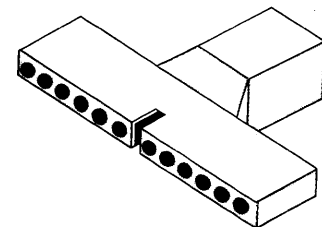

453762 SOLDERING IRO GROUND RAKE ASLT MSTX

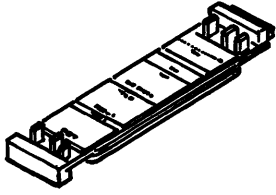

2360390

CARD EXTENDER - MULTI
TECHNOLOGY

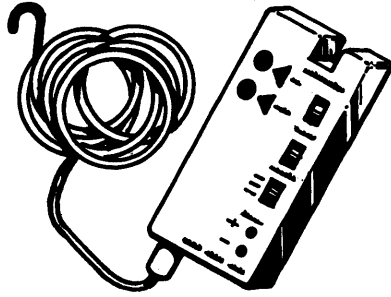

453212

GEN LOGIC PROBE

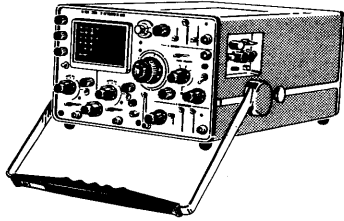

- 453164 ADAPTER, P 6010 TO 6-32 THREAD
- 453167 GROUND TIP, SLT SCOPE PROBE
- 453168 GROUND LEAD, 5 IN 127 MM
- 453178 TUBE, INSULATING, FOR 453161
- 453179 PROBE HOLDER
- 453180 CAP, PROTECTOR, FOR 453161
- 453181 TIP, RETRACTABLE HOOK, FOR 453161
- 453183 BAG, PLASTIC, PROBE ACCESSORIES
- 453184 ADAPTER, BNC TO BINDER POST
- 453185 POST, JACK
- 453189 RING, INSULATING, FOR 453161
- 461090 TIP, PROBE, HOOK SHANK, 6-32

- 3577 FUSE, 0.5 AMP, 3 AG INSTANT
- 111261 FUSE, 0.25 AMP, 3 AG INSTANT
- 111264 FUSE, 0.75 AMP, 3 AG SLO-BLO
- 332009 FUSE, 2.0 AMP, 3 AG SLO-BLO
- 453194 POWER CORD, 110V, 8 FT, FOR 453
- 453520 POWER CORD, 220V, 8 FT, TEKT. 453
- 453201 HOOK, FOLDING VIEWING, FOR TEKT. 453
- 461119 TIP, PROBE, 6-32
- 461159 CLIP, ALLIGATOR, PROBE, 6-32
- 5500750 HOOD, FOLDING VIEWING 454A

453047 SCOPE, TEKTRONIX 453 NOT AVAILABLE - REF. ONLY

FOR OSCILLOSCOPE
FAIRCHILD 766H

- 452382 PROBE ASM, 10 TO 1 ATTENUATION, 4298-A, TYPE 76-08 BNC
- 452814 PROBE ASM, 10 TO 1 ATT., 4298-A, MOD 102, TYPE 76-02
- 452808 VIEWING HOOD, FAIRCHILD 766 H
- 453200 POWER CORD, 110V, for
- 453200 POWER CORD, 110V, FOR FAIRCHILD 766 H
- 6325 FUSE, 1.0 AMP, 3 AG INSTANT
- 111256 FUSE, 1.5 AMP, 3 AG INSTANT
- 338165 FUSE, 3.0 AMP, 3 AG SLO-BLO
- 453049 FUSE FOR FAIRCHILD 766 H

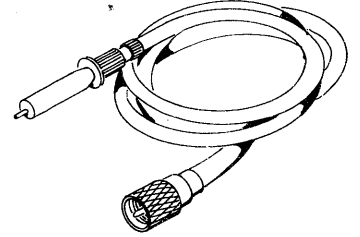

451922 PROBE ASM, 10 TO 1 ATTENUATION, P 6006 TEKT., UHF

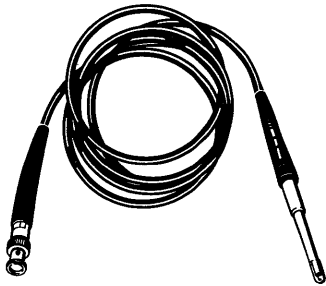

453161 PROBE, 1 TO 1 ATTENUATION
453187 SLEEVE ASM

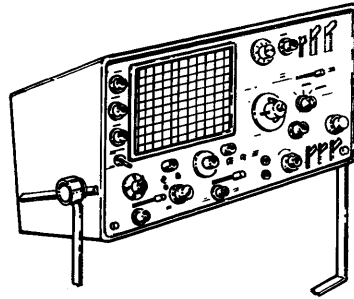

453550 OSCILLOSCOPE, 454A
NOT AVAILABLE -
REF. ONLY
453215 OSCILLOSCOPE, 475

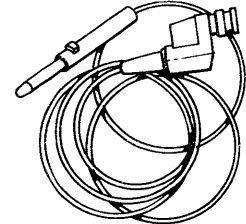

453675 PROBE, P6054

- 453216 PROBE, P6075
- 5500900 GROUND LEAD, 5 INCH
- 5500899 PROBE HOLDER
- 5500901 ADAPTER, 6-32
- 5500902 GROUND LEAD, 3 INCH
- 5500898 RETRACTABLE HOOK TIP
- 5495151 BODY AND SLEEVE ASM

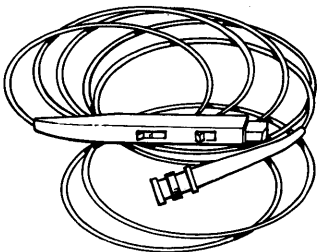

**5500903 PROBE, P6022, CURRENT,
9-FOOT

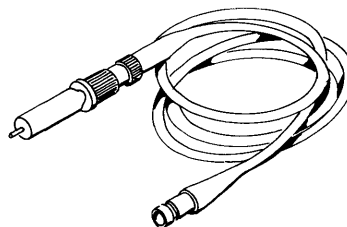

452805 PROBE ASM, 10 TO 1
ATTENUATION, P 6006 TEKT., BNC

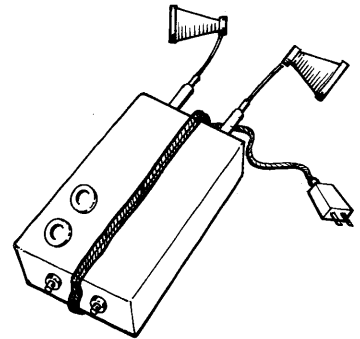

817971 PROBE, 100 NS INDICATOR,
SLD-MST SYS/3

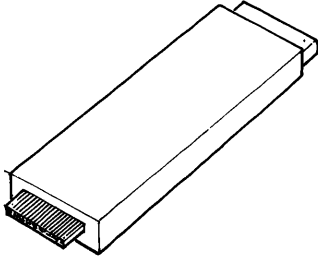

460274 EXTENSION, PREAMP, SCOPE

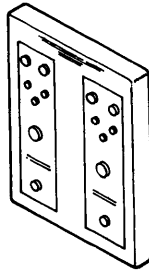

453553 DUAL TRACE PLUG IN UNIT TYPE 1A1

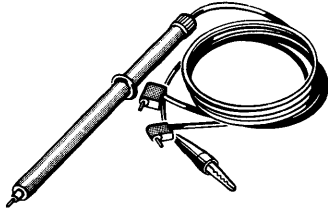

460670 PROBE, HIGH VOLTAGE, VOM

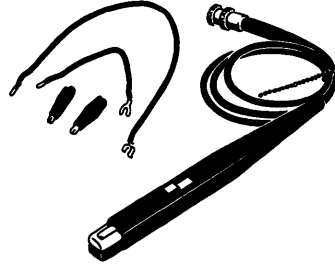

453515 PROBE ONLY, P 6019
453516 TERMINATOR ONLY, FOR P 6019



440140 ADAPTER, SCOPE TERMINAL, BINDING POST



450837 ADAPTER, COAX, SCOPE



453165 TERMINATOR, PASSIVE FOR 6016



461031 ADAPTER, TEE, COAX, UHF

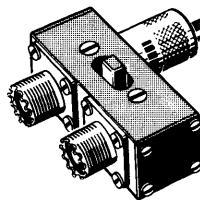

450934 SWITCH, COAX, DUAL INPUT, SPDT, SCOPE

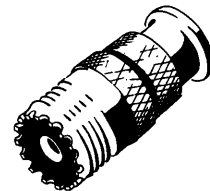

460805 ADAPTER, BNC TO COAX

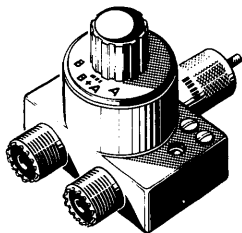

451129 SWITCH, COAX, PROBE, SCOPE

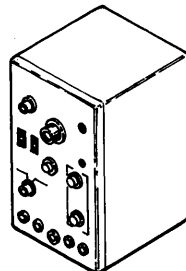

** 453551 PLUG-IN, SAMPLING SWEEP 561A

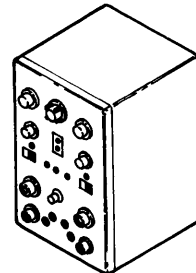

** 453552 PLUG-IN, DUAL TRACE SAMPLING 561A

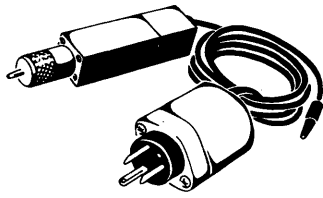

451127 CHOPPER BOX, SCOPE

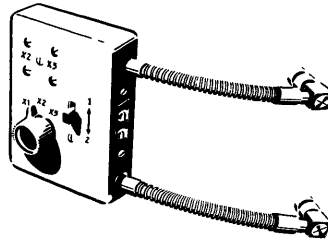

453048 PROBE ADAPTER
2414943 ISOLATION TRANSFORMER

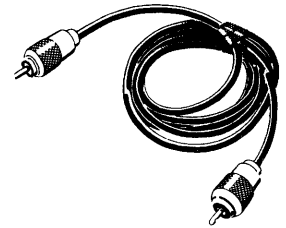

451013 CABLE ASSEMBLY,
COAXIAL, 6 FT

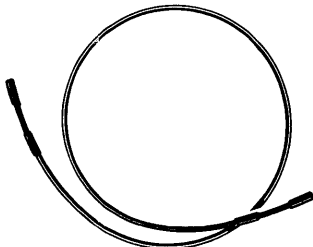

2129264 JUMPER, 18 IN., INSULATED
2197864 JUMPER, 15 IN.
2200079 JUMPER, 36 IN.



451060 PROBE ASM, GROUND WIRE

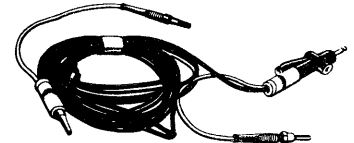

*4261093 SYNC LEAD, SHIELDED
4261081 TEST LEAD, SHIELDED
4261080 COUPLING, BANANA
PLUG, 6-32
451659 BANANA TIP, 6-32
461119 TIP, PROBE, 6-32

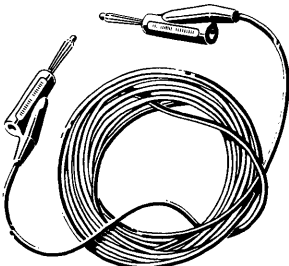

LEAD TEST, 2 METER
* 489958 RED
* 489959 BLUE



451653 LEAD ASM, 10 FT, BANANA
TIP AND PROBE TIP
451659 BANANA TIP, 6-32
451880 CONNECTOR ASM., 6-32
461119 TIP, PROBE, 6-32

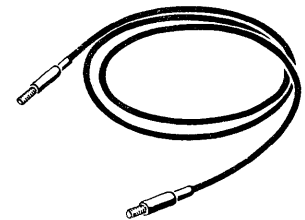

TEST LEAD 6, 6 FT, 6-32
*4261108 RED
*4261109 GREEN

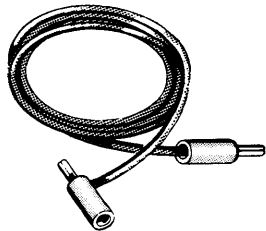

LEAD, ELEC, 8FT, BANANA PLUGS
512881 RED
512882 BLK

451654 LEAD ASM, 2 FT, BANANA
TIP AND PROBE TIP
451880 CONNECTOR ASM., 6-32
461119 TIP, PROBE, 6-32

451655 LEAD ASM, 6, 6FT, BANANA
TIP AND PROBE TIP
451880 CONNECTOR ASM., 6-32
461119 TIP, PROBE, 6-32

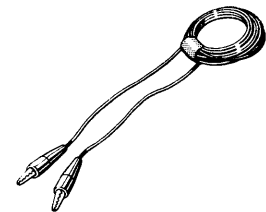

LEAD, ELEC, 10 FT, ALLIGATOR CLIPS
2108049 RED
2108050 BLK

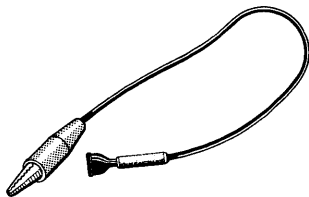

LEAD, ELEC, 12IN., ALLIGATOR CLIPS
2108156 BLK
2108157 RED

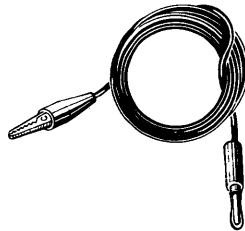



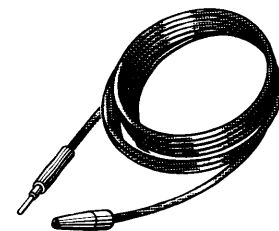





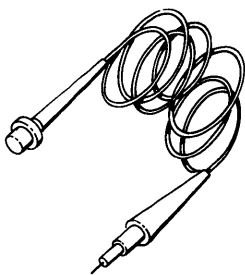
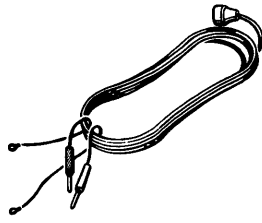
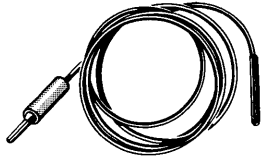

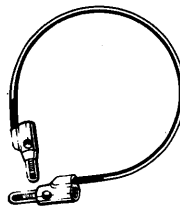
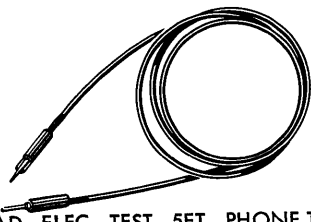
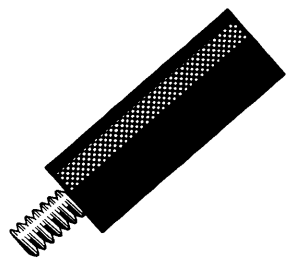
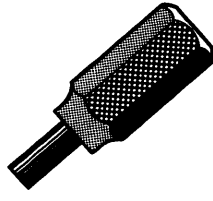
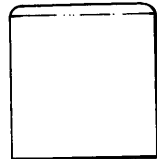



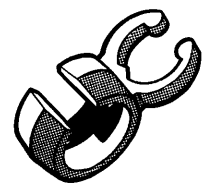

LEAD, ELEC, 10FT, ALLIGATOR-BANANA
2124529 BLK
2124530 RED

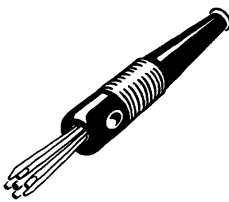

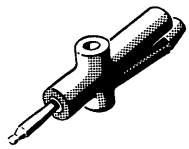

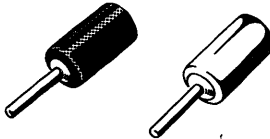
LEAD, ELEC, TEST, 12 FT, PIN-CLIP
450839 RED
450840 BLK

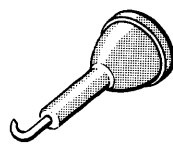
Group 17

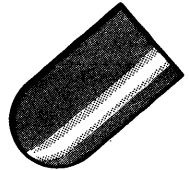
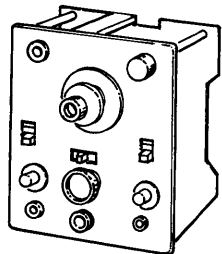
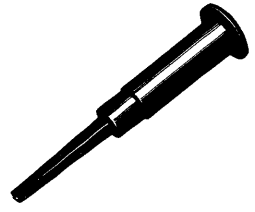
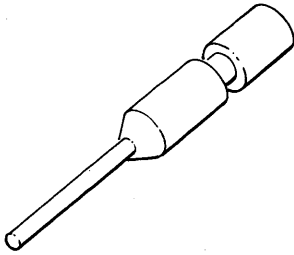
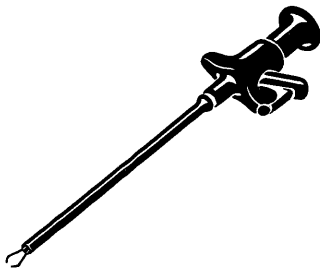
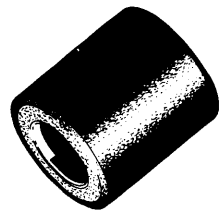
 <p>453548 PROBE, OSCILLISCOPE P6034 10X</p>	 <p>461175 PROBE ASSEMBLY, SYNC LINE</p>	 <p>2124599 LEAD, ELEC, 6 FT, BANANA-BELLY DANCER</p>
 <p>453168 GROUND LEAD, 5 IN. 461092 LEAD, ELEC, 12 IN. GROUND, 6 - 32</p>	 <p>451212 LEAD, ELEC, 12 IN., RED, BANANA PLUGS</p>	 <p>LEAD, ELEC, TEST, 5FT, PHONE TIPS, 450757 BLK 450758 GREEN 450759 RED</p>
 <p>453164 ADAPTER, P6010 TO 6-32</p>	 <p>453167 GROUND TIP, SLT SCOPE PROBE</p>	 <p>453178 TUBE INSULATING FOR 453161 AND 453162</p>
 <p>461159 CLIP ALLIGATOR PROBE, 6-32</p>	 <p>512888 CLIP, ALLIGATOR, SCOPE PROBE</p>	 <p>CLIP, ALLIGATOR, INSUL 5230053 BLACK 5230054 RED</p>
 <p>450842 CLIP, ALLIGATOR, INSUL, RED 452387 INSULATING BOOT RED FOR 450842 450843 CLIP, ALLIGATOR, INSUL, BLACK 452388 INSULATING BOOT BLACK FOR 450843</p>	 <p>460964 CLIP, ALLIGATOR, COAX PROBE</p>	 <p>453179 PROBE HOLDER</p>

 <p>PLUG BUNCHED</p> <p>*4121047 BLACK *4121075 RED</p>	 <p>451659 BANANA TIP, 6-32</p>	 <p>*4261080 COUPLING, BANANA PLUG, 6-32</p>
 <p>451880 CONNECTOR ASM, 6-32</p>	 <p>PLUG, TIP</p> <p>461118 10-32 461119 6-32</p>	 <p>TIP, PROBE</p> <p>461118 10-32 461119 6-32</p>
 <p>TIP, SCOPE</p> <p>512889 HOOK, ATTENUATOR PROBE 512890 STRAIGHT, ATTENUATOR PROBE</p>	 <p>461090 TIP, PROBE, HOOK SHANK, 6-32</p>	 <p>461091 TIP, PROBE, STRAIGHT SHANK, 6-32</p>
 <p>453180 CAP, PROTECTOR, FOR 453161 AND 453162</p>	 <p>** 453519 PLUG-IN UNIT, TYPE 2A63 DIFF. AMPLIFIER</p>	 <p>453181 TIP, RETRACTABLE HOOK, FOR 453161 AND 453162 461086 TIP, RETRACTABLE HOOK, FOR 451922 AND 452805</p>
 <p>450778 TIP, TEST, SCOPE PROBE</p>	 <p>*4621006 PROBE, BANANA PLUG, CONNECTION</p>	 <p>453188 TUBE, INSULATING FOR 451922 AND 452805</p>

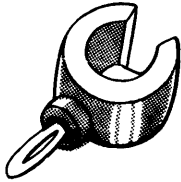
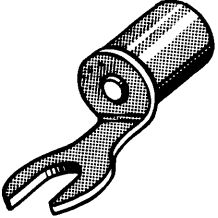
Group 17

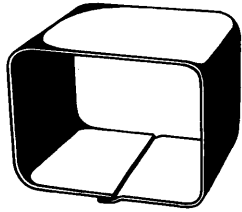
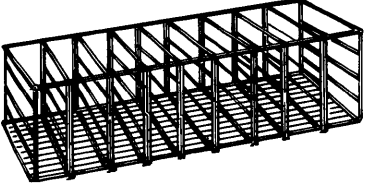
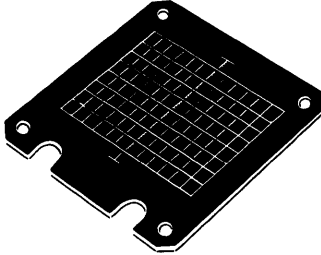
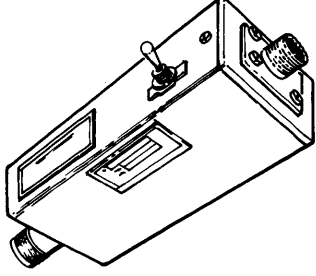
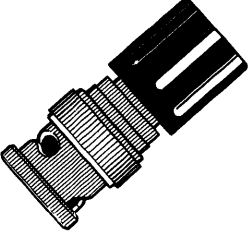
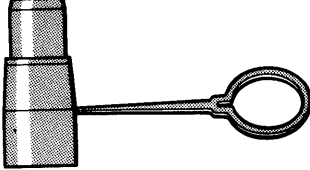
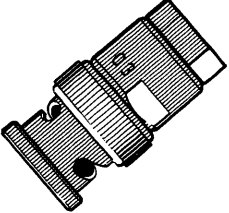
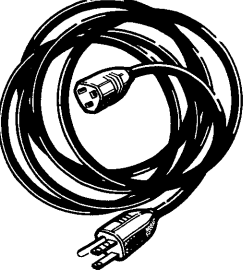
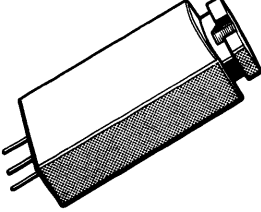
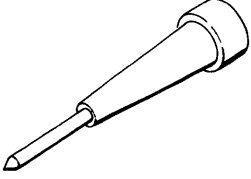
 <p>*4261006 PROBE, BANANA PLUG CONNECTION</p>	 <p>461087 HOLDER, PROBE, SCOPE</p>	
 <p>TERMINAL, LUG, SPADE 512885 RED 512886 BLK</p>	 <p>451881 ADAPTER, 1/4 IN. LG., 10-32 TO 6-32</p>	 <p>451919 SHIELD, LIGHT, FOR SCOPE TEXT 561A</p>
 <p>453148 CART TOP UNIT, 8.5 X 11 BINDERS</p>	 <p>450917 GRATICULE, 3 IN., SCOPE, 650 SYSTEM</p>	 <p>**461274 TEST, REFERENCE, OSCILLATOR (7074-80-90)</p>
 <p>453184 ADAPTER, BNC TO BINDER POST</p>	 <p>453185 POST, JACK</p>	 <p>453199 ADAPTER, PROBE TIP TO BNC</p>
 <p>* 460626 POWER CORD, 14 IN., TEKT</p>	 <p>2200052 ADAPTER, SCOPE HEAD ALIGNER, 1130</p>	 <p>5500864 SPRING TIP</p>



453147 MANUAL AND SCOPE
CART, 36 VOL.
453154 CASTER
453549 SOCKET

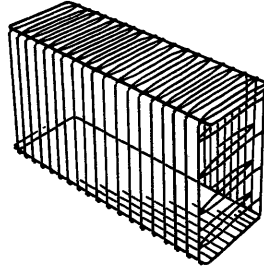

453149 FRAME MANUAL B SIZE
FOR 453147

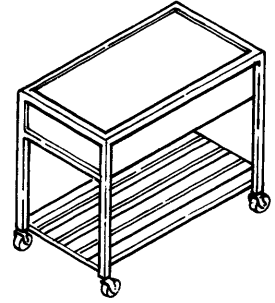

453699 CART, SMALL SYSTEMS
5495166 SEPRATOR

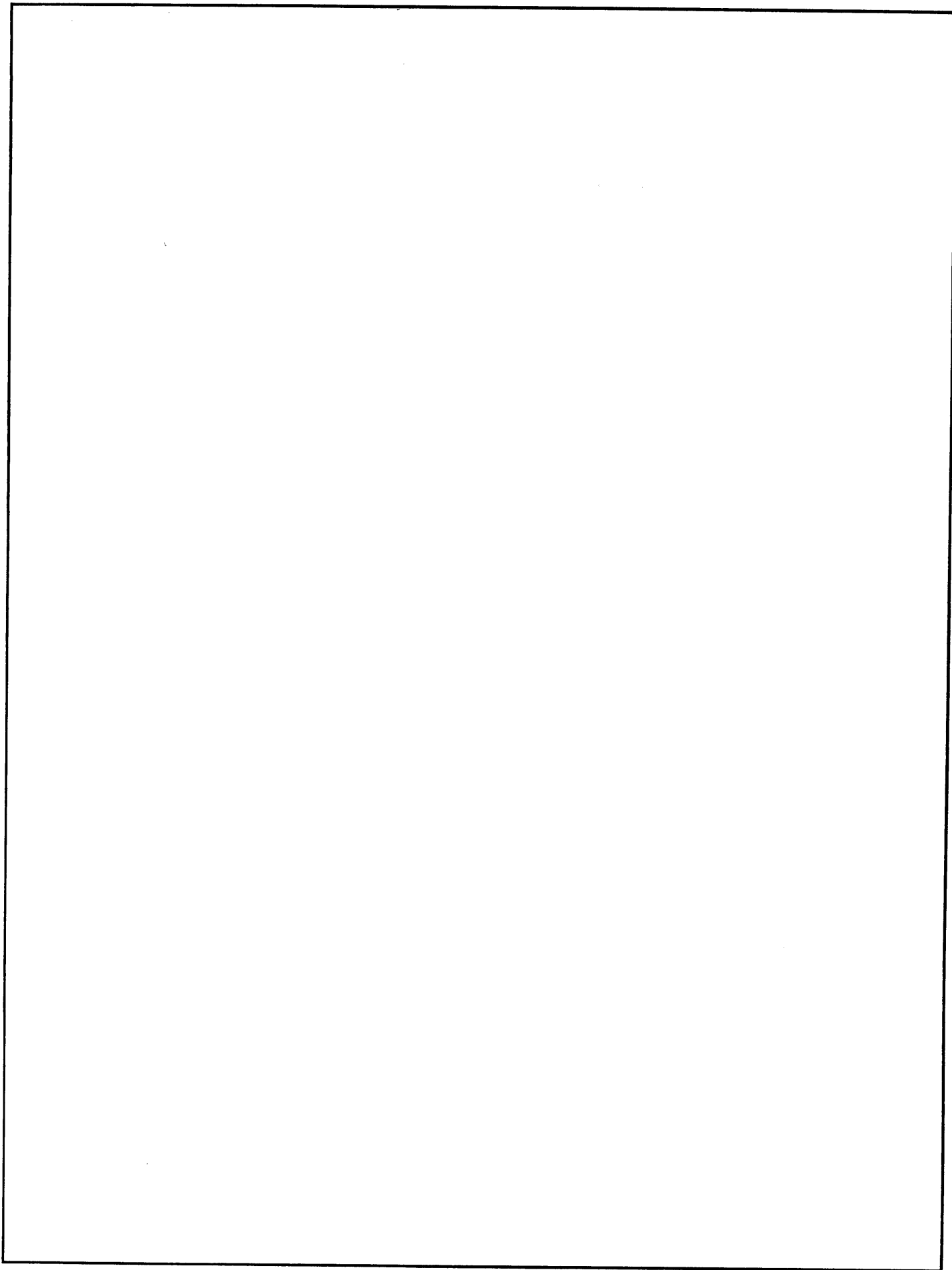

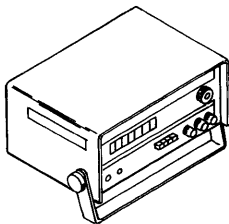
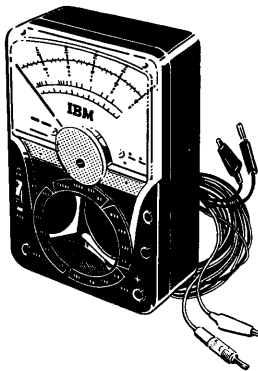
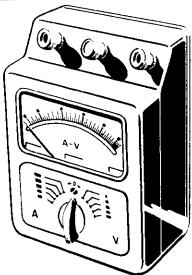
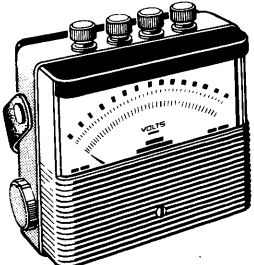
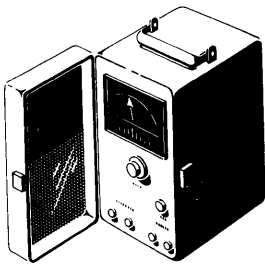
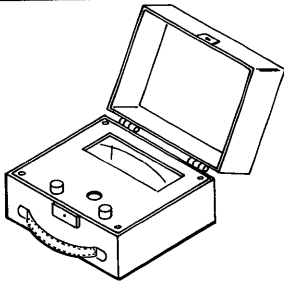
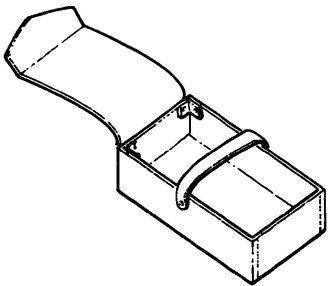
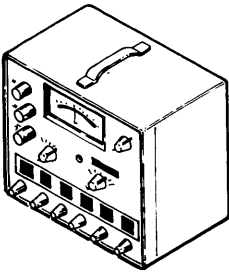
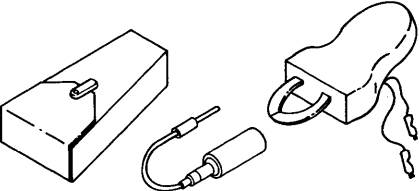
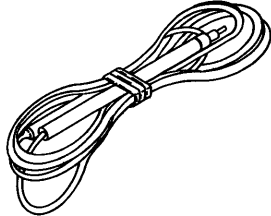
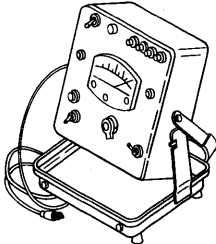
	 <p>** 453585 VOLT METER, DIGITAL DIGITEC 266, 100-220V</p>	 <p>452796 MULTIMETER ASM, VOM 452793 TEST LEAD RED, FOR 452796 452794 TEST LEAD BLACK, FOR 452796 452786 FUSE, PLUG-IN, FOR 452796 452806 FUSE, FOR RED LEAD 453614 FUSE FOR FUSE CAP</p>
 <p>** 460880 AC METER, 6-30-150-300-600 V, 0,006-0,3-1,5-6-30 A</p>	 <p>460879 WESTON 901 DC METER, 3-15-30-75-150-300-75 V</p>	
 <p>** 453545 TRANSMISSION MEASURING SET, DECIBEL METER</p>	 <p>**5258785 PYROMETER, PORTABLE</p>	 <p>453514 METER CASE</p>
 <p>** 453191 METER, FLUKE, NULL TYPE DC</p>	 <p>453554 AMPROBE, MODEL RS-3 453555 PLUG, OHMMETER</p>	 <p>313738 LEAD, ELEC, TEST PROBE</p>
		 <p>** 453540 MEOHMMETER</p>

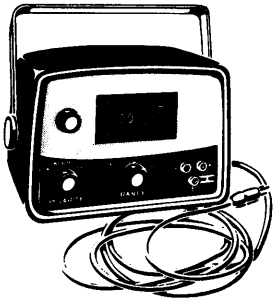

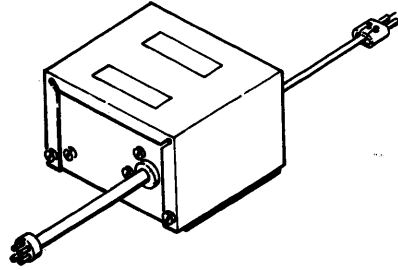

** 453046 VOLTMETER, DIGITAL, 110V
** 453648 VOLTMETER, DIGITAL,
210 - 250V



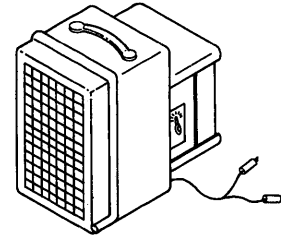

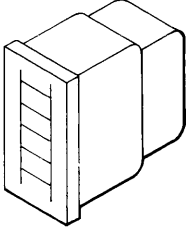

2604621 METER CONVERTER,
MOTOR GENERATOR
370/135
2646774 METER CONVERTER,
MOTOR GENERATOR
370/145

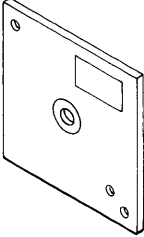
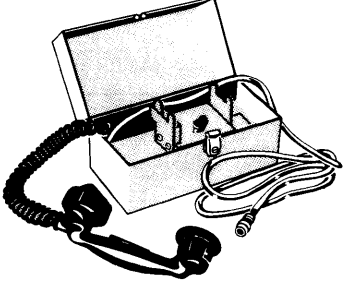
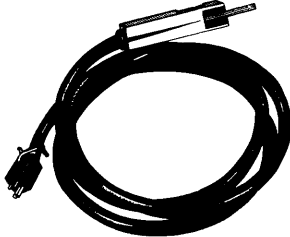
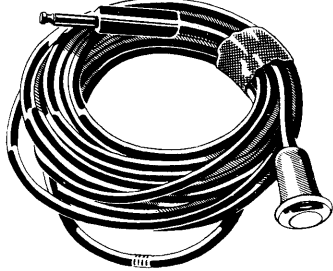
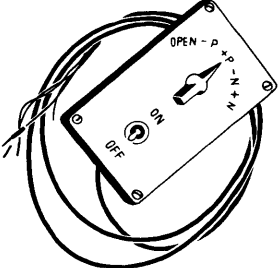
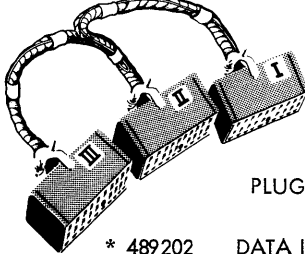
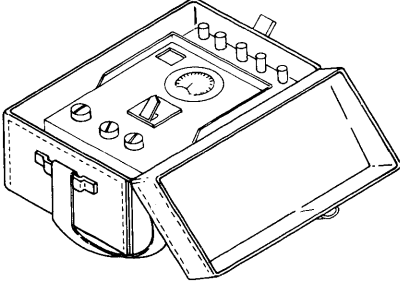
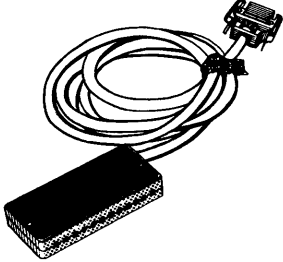
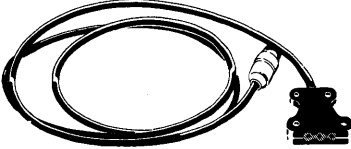
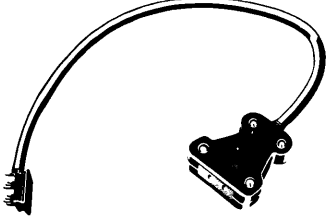
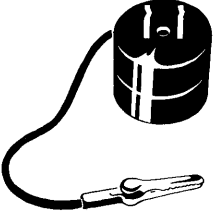
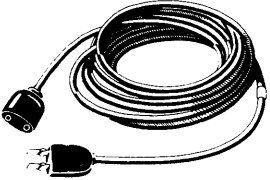

453571 VOLTMETER, AC RECORDING
453573 PAPER, CHART
453574 KIT, ACCESSORY
453586 FLUID, WRITING
453592 ELEMENT, PEN
453595 WELL, INK

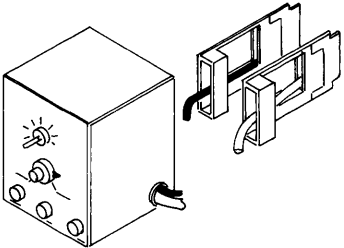
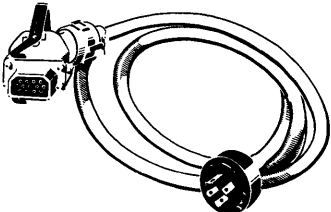
 <p>2244974 CABLE ASM, CE WRITE CURRENT TOOL</p>	 <p>761325 REMOTE BOX, STOP START</p>	 <p>2200345 DISK ASM, CE 23FD</p>
 <p>*8019963 COAXIAL PORTABLE PHONE</p>	 <p>322992 KEY ASM, SWITCH, MACHINE CYCLE</p>	 <p>454304 CABLE ASSEMBLY, PORTABLE START KEY</p>
 <p>452390 INJECTOR, DC LEVEL</p>	 <p>PLUG SET, * 489202 DATA INPUT, PA 024, 026 * 489203 DATA OUTPUT, PB 024, 026</p>	 <p>** 453537 TESTER, EARTH-MEGGER NULL BALANCE</p>
 <p>124660 CYCLE INDICATOR</p>	 <p>450953 CABLE ASSEMBLY, HEAD READER</p>	 <p>461068 CABLE ASSEMBLY, TIMING TRACK TRANSFER</p>
 <p>460624 ADAPTER, 3 WIRE PLUG TO 2 WIRE RECP.</p>	 <p>460627 CORD ASSEMBLY, 3-WIRE PLUG AND RECP., 8 FT., 110 V TEKTRONIX 500 SERIES</p>	 <p>460196 CORD EXTENSION, 2 MALE - 3 FEMALE 12 FT., 027</p>

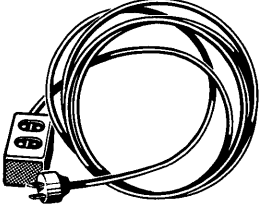
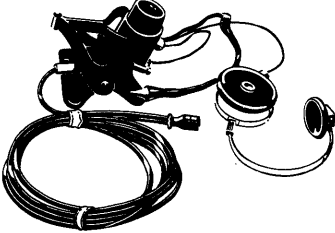
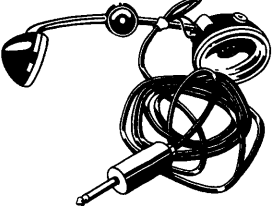
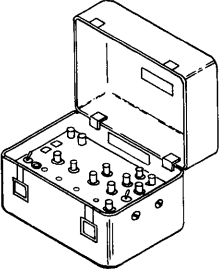
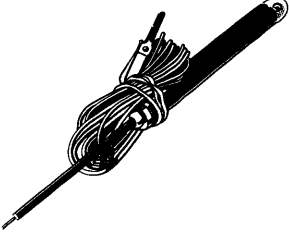
Group 19

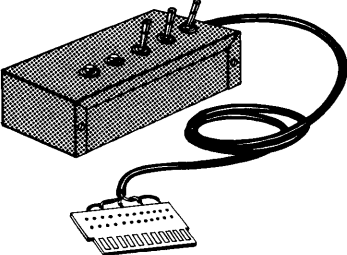
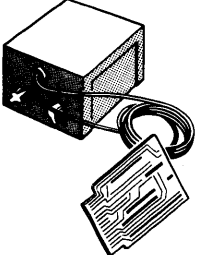
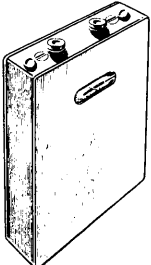
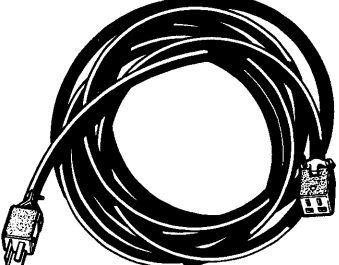
 <p>5496935 SERVICE AID ASM, INTERFACE POWER 2914-1</p>	 <p>*2086587 POWER CABLE, 50HZ, 380V, 240X, 2420 *8012757 POWER CABLE, 50HZ, 380V, 729 ONLY</p>	 <p>*4111067 ADAPTER CABLE US/SCHUKO 220V</p>
 <p>5222564 OUTLET ASM, CONVENIENCE 25 FT, EXT, 3-WIRE</p>	 <p>460260 HEADSET, TELEPHONE, SOUNDPOWER</p>	 <p>460064 HEADSET, TELEPHONE</p>
 <p>453599 LINE INTERROGATION DEVICE ASM, 60HZ 453649 LINE INTERROGATION DEVICE ASM, 50HZ</p>	 <p>802000 LIGHT ASM, TEST, 48 VDC, 8 FT</p>	 <p>452803 NEON PROBE 029/059</p>
<p>453599 LINE INTERROGATION DEVICE ASM, 60HZ 453649 LINE INTERROGATION DEVICE ASM, 50HZ</p>	 <p>727468 REMOTE BOX, STOP-START BUFFER MACH. 1447-2 U.4</p>	 <p>461165 DELAY LINE ASSEMBLY, VARIABLE</p>
 <p>* 489944 CIRCUIT TESTER WITH NEON BULB</p>	 <p>460893 CABLE ASM., START AND RESET EXTENSION</p>	

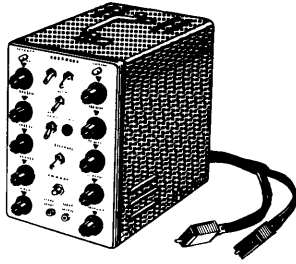

2108151 CE MAINTENANCE BOX 305

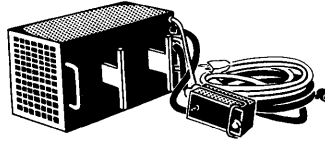

*4117310 MARGINAL CHECK POWER SUPPLY 3 V 5 AMP 50 HZ
 ** 210860 MARGINAL CHECK POWER SUPPLY 3 V 5 AMP 60 HZ

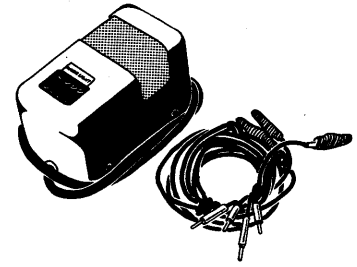

* 454105 POWER SUPPLY, DYNAMIC TIMER TUBE, 6 SL 7 GT
 206913 TUBE, 6 H 6 GT
 206914 TUBE, 6 H 6 GT
 206916 VIBRATOR

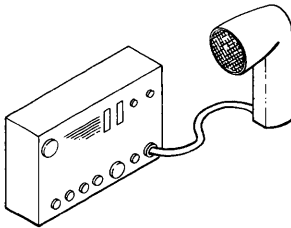

** 453600 STROBOSCOPE, IBM
 5442582 FLASH TUBE
 5442557 PHOTO ELECTRIC PICK OFF UNIT

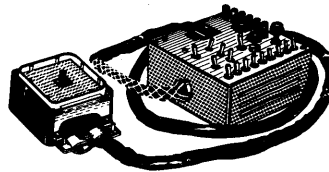

5420330 TAPE DRIVE TESTER, 2401-2-3, MOD. 1 TO 6
 5417910 TERMINATOR, FOR 5420330

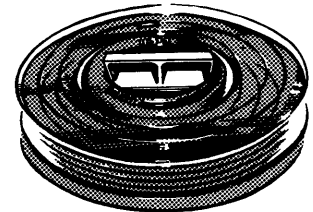

**2200001 DISK CARTRIDGE 1130
 **2200018 CE DISK PACK TYPE 1311-2311
 2200100 DISK PACK 2314
 **2200420 DISK PACK, CE, 3330
 2537301 CARTRIDGE, DISK-CE, 5444

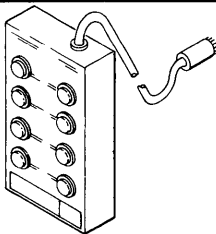

453610 DYNAMIC TIMER ASSEMBLY
 5442707 TRANSFORMER
 5442710 SCREW, NYLON
 5442712 FUSE
 5442715 JACK

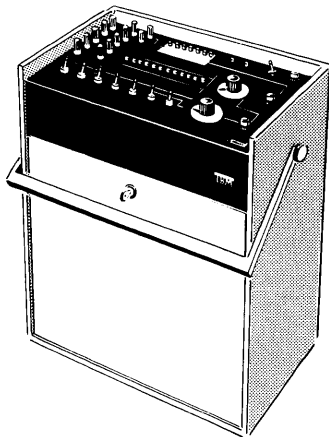

622285 PORTABLE CE AID 1030

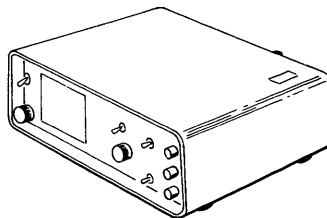

9900175 DYNAMIC RELAY TESTER
 9900181 MERCURY RELAY

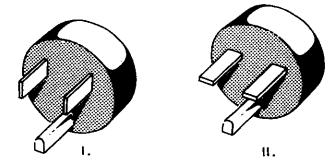

I. * 256341 PLUG, 115V.
 II. * 256342 PLUG, 230 V.

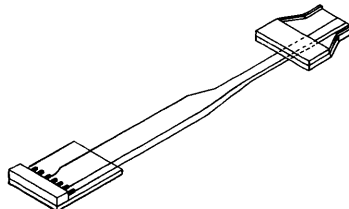

5390876 EXTENDER ASM, CARD WORD AND LINE
 5702426 EXTENDER ASM, CARD WORD AND LINE 2361

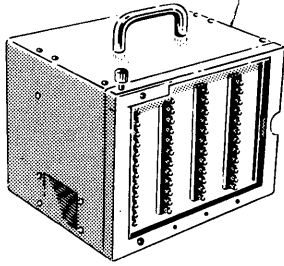

- 821050 CE INDICATOR BOX
- 821075 FACE PLATE 1421
- 821077 FACE PLATE 1448
- 821078 FACE PLATE 1443
- 821079 FACE PLATE 1441 - 1442
- 821080 FACE PLATE 1447
- 821081 FACE PLATE 1446
- 821083 FACE PLATE 1444
- 821084 FACE PLATE 1311 - 1301
- 830292 FACE PLATE 1026
- 832502 FACE PLATE 1009
- 2108876 FACE PLATE 1311 MOD 4
- 821099 CABLE ASM 1440

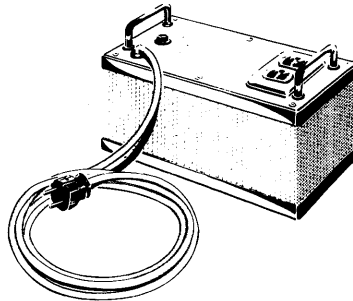

- *4210110 PORTABLE TRANSFORMER
220 - 110 V 200 W 50HZ
- 452790 PORTABLE TRANSFORMER
208-115V 850W 60HZ

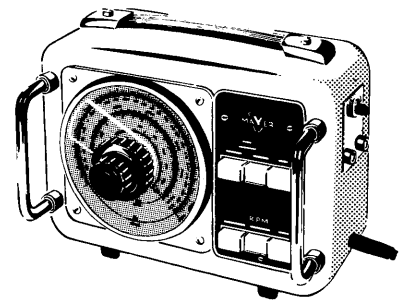

- *4261074 STROBOSCOPE ASM
- *4261075 XENON FLASH BULB FOR 4261074
- *4261091 CARRYING CASE :FOR 4261074
- *4261094 SAFETY SPECTACLES 65% DARK

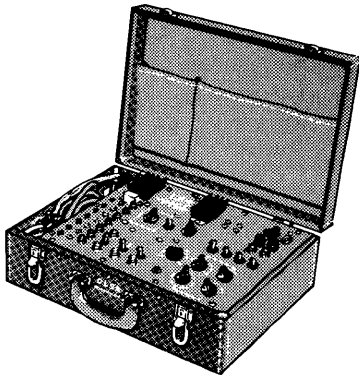
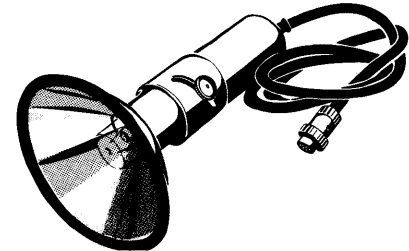

- **9900385 OFF LINE SELECTRIC ANALYZER, OLSA
- 747579 PADDLE CARD, OLSA, 1053-1,
1052-1 THRU 6
- 9900245 ADAPTER CABLE 731 CORRESPONDENCE
- 9900246 ADAPTER CABLE 731 BCD
- 9900249 ADAPTER CABLE 1014
- 9900250 ADAPTER CABLE 765 - 767
- 9900312 ADAPTER CABLE 1062
- 9900313 ADAPTER CABLE 1620 MOD 2
- 9900314 ADAPTER CABLE 775 MT-ST
- 9900315 ADAPTER CABLE 865
- 9900318 PULS CONTROL
- 9900322 24 VOLT ADAPTER
- 9900350 ADAPTER CABLE 1033
- 9900351 ADAPTER CABLE 1052 - 7
- 9900352 ADAPTER CABLE 1053 - II
- 9900353 ADAPTER CABLE 1053 - II - IV, 1816
- 9900354 ADAPTER CABLE 1052 - 7
- 9900355 ADAPTER CABLE 1052 - 8
- 9900393 ADAPTER CABLE 835-935
- 9900394 ADAPT BOX 1033, 1052, 1053,
1062, 1131, 1447, 1816
- 9900395 ADAPTER BOX 865 - 1014 - 1415
- 9900416 ADAPTER BOX 2152
- 9900434 ADAPTER BOX 835 - 935 - 2970

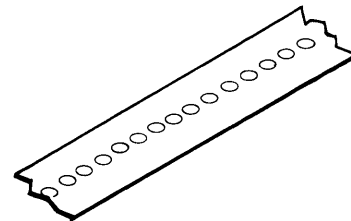

- 450679 TAPE, PAPER, CARRIAGE, 407
- 450684 TAPE, CARRIAGE TEST 402
- 461198 TAPE, PAPER, DIAGNOSTIC 1401
- 461252 TAPE, PAPER, DIAGNOSTIC,
MAPT 01A, 7273
- 461253 TAPE, PAPER, DIAGNOSTIC,
MAPT 02A, 7273
- 461254 TAPE, PAPER, DIAGNOSTIC,
MAPT 03A, 7273
- 461255 TAPE, PAPER, DIAGNOSTIC,
MAPT 04A, 7273
- 461256 TAPE, PAPER, DIAGNOSTIC,
MAPT 05A, 7273
- 461257 TAPE, PAPER, DIAGNOSTIC,
MAPT 06A, 7273
- 461258 TAPE, PAPER, DIAGNOSTIC,
MAPT 07A, 7273
- 461259 TAPE, PAPER, DIAGNOSTIC,
MAPT, 08A, 7273

- 9900452 ADAPTER BOX 1620 II
- 9900456 SWITCH 110 - 220 V
- 2492000 ADAPTER CABLE 2980 MOD 1, 2, 4
- 9900247 ADAPTER CABLE, OLSA - T
- 9900248 ADAPTER CABLE OLSA - T
- 9900356 ADAPTER CABLE, OLSA - T
- 2492775 ADAPTER CABLE, OLSA, 2946
- 2491996 ADAPTER BOX, OLSA - T, 2980
MOD 1, 2, 4
- 9900389 ADAPTER BOX, OLSA
- 9900289 ADAPTER BOX, OLSA
- 9900450 ADAPTER BOX, OLSA

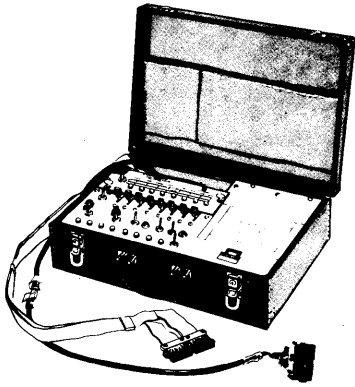

**2200012 TESTER, ON LINE - OFF LINE
2311

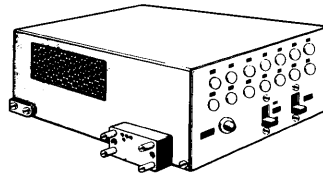

1272825 CE AID BOX
2740 - 2741

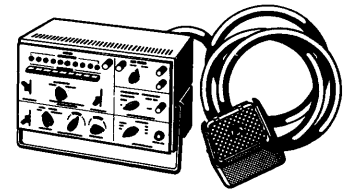

** 461445 TESTER, FUNCTIONAL,
HYPERTAPE
** 461445 TESTER, FUNCTIONAL,
HYPERTAPE
** 461222 TESTER, FUNCTIONAL,
7340 MOD 3

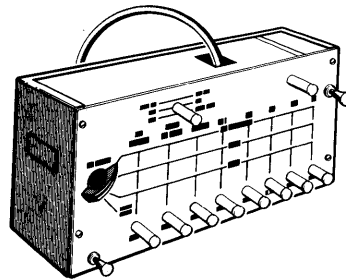

**2200014 FILE INDICATOR BOX
2311 - 2314

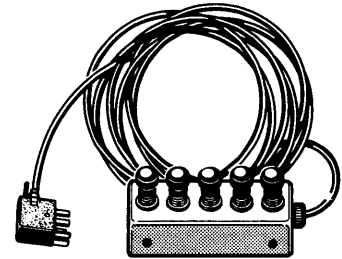

2100937 BOX ASM., SYNCHRO PANEL,
REMOTE CONTROL

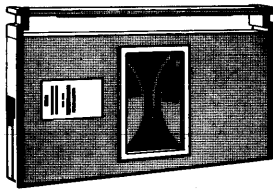

432642 TAPE, MAGNETIC, PRE-AMP
CALIBRATION 7340-3
461224 TAPE ASM, PRE-AMP, 7340
461225 TAPE ASM, MASTER SKEW, 7340

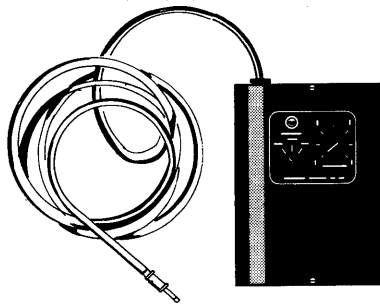

**5712439 TESTER, PORTABLE BIAS BOX

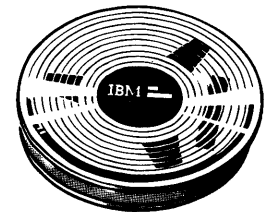

432152 TAPE, MAGNETIC,
SIGNAL LEVEL, 729-2, 7330
432153 TAPE, MAGNETIC,
MASTER SKEW, 800 BPI
432640 MASTER SKEW TAPE
432641 MASTER SKEW TAPE 7-9 TRACK
461108 STANDARD PRE-AMP, TAPE
503928 TAPE, MAGNETIC, MASTER
SKEW 200 BPI
1161480 CARTRIDGE ASM, TAPE,
100 FT 2% 50

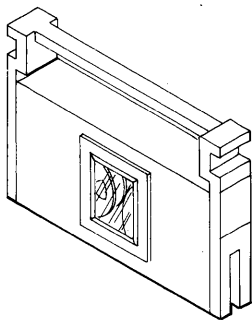

9900329 TAPE, TEST, GRP TYPE OUT
9900330 TAPE, TEST, ADD
9900331 TAPE, EST
9900331 TAPE, TEST, SUBTRACT
9900332 TAPE, TEST, MULTIPLY
9900333 TAPE, TEST, A FUNCTIONAL
9900334 TAPE, TEST, B FUNCTIONAL
9900335 TAPE, TEST, ROCS
632
453678 CASSETTE, ENDLESS LOOP
TDAT

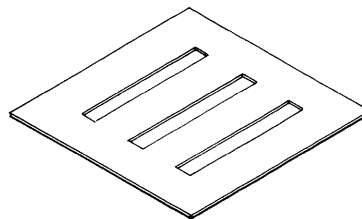

674027 PANEL, CE AID, PRINTER 6 BIT
EBCDIC
674028 PANEL, CE AID, RDT/PCH 6 BIT
EBCDIC
674029 PANEL, CE AID, BUFFER 6 BIT
EBCDIC
674030 PANEL, CE AID, BSA 6 BIT
5153373 PANEL, CE AID, BSA EBCIDC
5153375 PANEL, CE AID, BSA ASCII
5155335 PANEL, CE AID, PRINTER ASCII
5155336 PANEL, CE AID, RDR/PCH ASCII

5155337 PANEL, CE AID BUFFERS ASCII
2780
680763 PANEL, CE AID,
1978-B

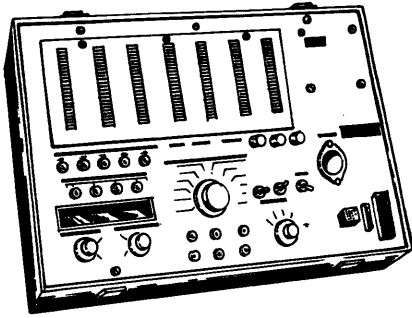

**453596 NEW SELECTRIC TESTER - NEST

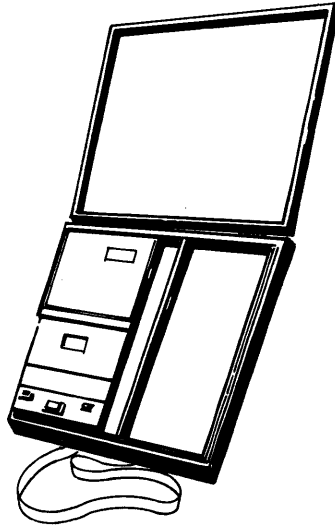

5500746 CASSETTE RECORDER
5500749 CARRYING CASE
5500747 AC ADAPTER
5500748 LABEL - USE ALCOHOL ONLY

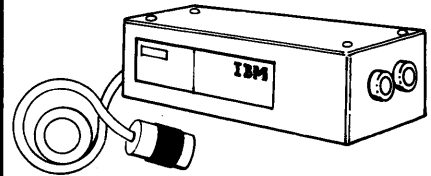

453646 LINE SCOPING TRANSFORMER

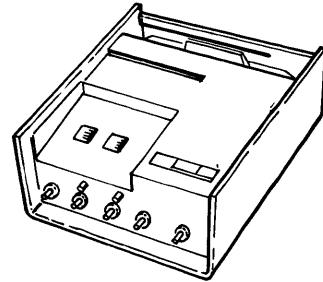

1765342 TESTER, FUNCTIONAL, 3420
2513000 TESTER, FUNCTIONAL, 2420

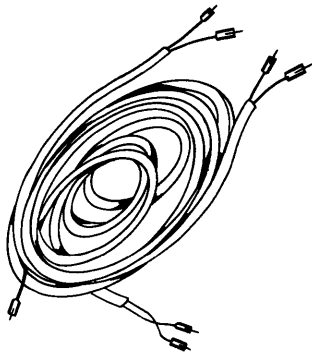

2703978 AI CALIBRATE CABLE, SYS 7

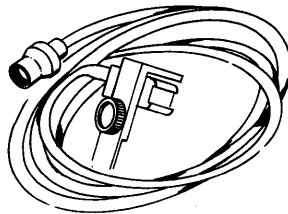

453674 MAGNETIC PICK UP, 059

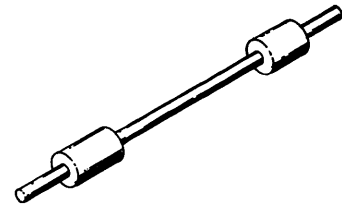

5888206 AI TEST JUMPER
2 INCH, SYS 7

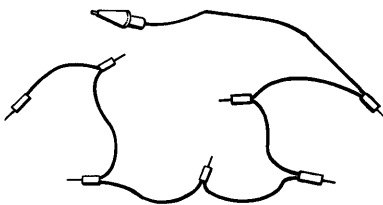

2703977 CABLE TERMINATOR, SYS 7

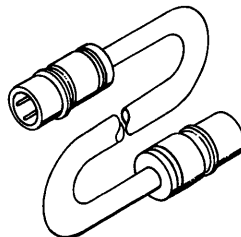

5258789 CABLE ASM, CALIBRATION,
PRE BEATER
5258790 CABLE ASM, CALIBRATION,
APRON BLOCK

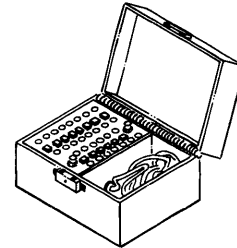

**2200054 BOX, CE CONTROL
360/44

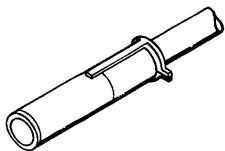

2183478 ADAPTER CORD, PHONE
1800-1826

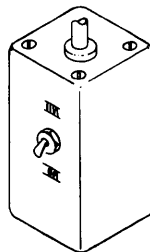

857434 SWITCH ASM, CE RUN CONTROL
1421, 1979

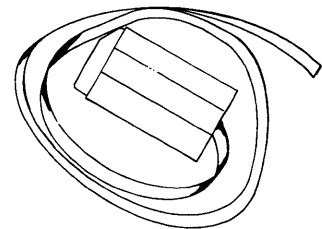

461247 TESTER, CAPSTAN TORQUE,
HYPERTAPE

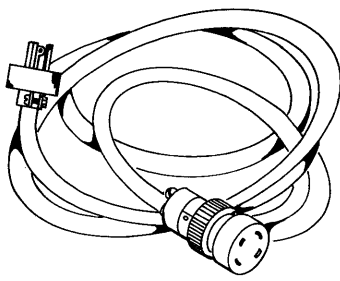

461230 CABLE, POWER

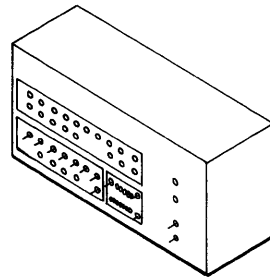

** 453630 CONTROL UNIT, SIMULATOR

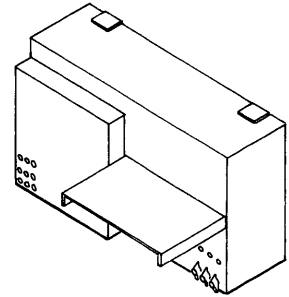

452394 SIMULATOR, COMMUNICATIONS SYSTEM

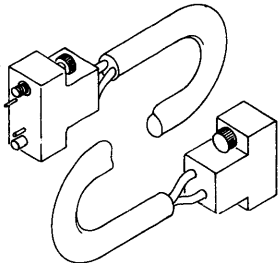

453576 CABLE ASM, VIDEO TEST
453577 CABLE ASM, KEYBOARD TEST
453578 CABLE ASM, PRINTER TEST 2948

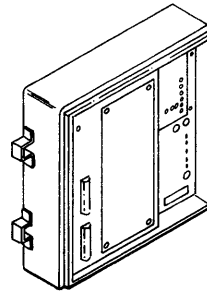

453611 TESTER, FUNCTIONAL 7340

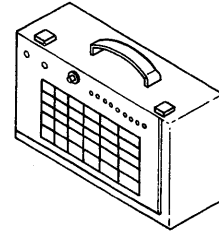

** 453625 TRACER ASM, ROS ADDRESS

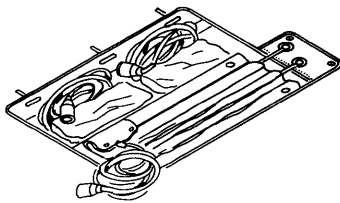

453538 KIT, ACCESSORY

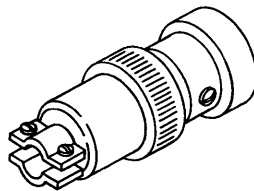

461229 PLUG, REMOTE POWER ON 7340

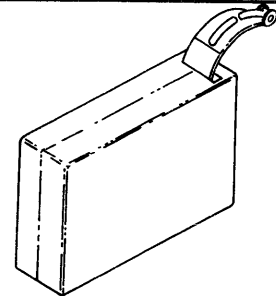

5471459 TAPE, MASTER 50

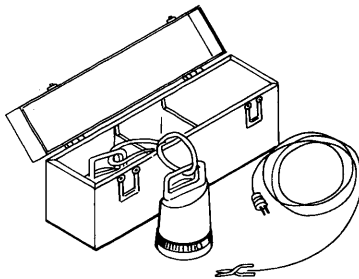

453542 KIT, CONDUCTIVITY TEST

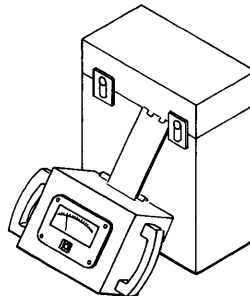

** 453541 LOCATOR, ELECTROSTATIC, TYPE E

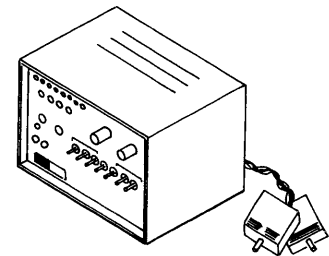

** 453670 TESTER, MANUAL INTERFACE

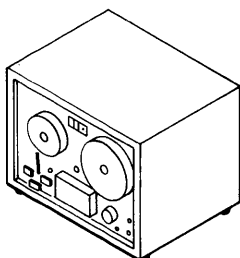

**2728218 PLAYER, TAPE, FOUR TRACK
453696 CASE ASM, FOUR TRACK TAPE PLAYER

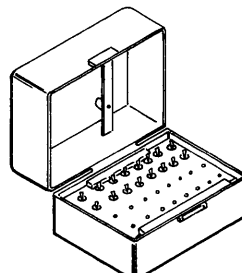

**2570250 TESTER ASM, CE 3270

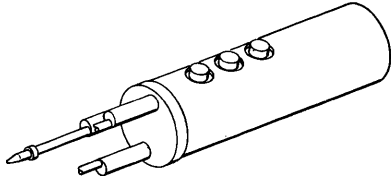

453203 CHECKER ASM, PHASE SEQUENCE

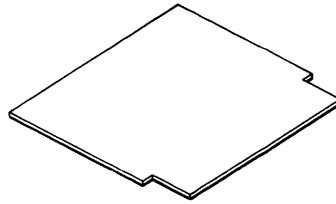

5861448 THRESHOLD ADJ. CARD
5861452 NRZI THRESHOLD CARD

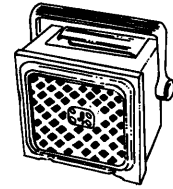

SIGNAL CABLE TERMINATOR

- ** 348590 729
- ** 348591 729
- ** 556801 7330
- **5356195 2400
- **5311035 7340 MOD 1, 2
- **5367876 7340 MOD 3
- **5373693 2840 MOD 1
- **5417978 2840 MOD 2

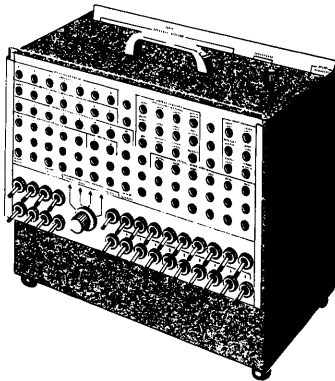

- ** 452400 I-O TESTER
- 634499 TESTER OVERLAY 1442 N 1
- 647228 TESTER OVERLAY 2501
- 647521 TESTER OVERLAY 2501B
- 647625 TESTER OVERLAY 2520B
- 820324 TESTER OVERLAY 1443 N 1
- 825369 TESTER OVERLAY 2030 - 1050
- 827047 TESTER OVERLAY 2821 - 1403 - 2540
- 837890 TESTER OVERLAY 2540 - 1403
WITH UNIV. CHAR. SET"
- 838163 TESTER OVERLAY UCS DATA ENTRY SW.
- 838173 TESTER OVERLAY 1404 - 2540
- 2193977 TESTER OVERLAY 2841
- 2250852 TESTER OVERLAY 2314 - 2844
- 2506166 TESTER OVERLAY 2968 - 7
- 2984249 TESTER OVERLAY 2826
- 5159315 TESTER OVERLAY 2701 - SDA II
- 5180928 TESTER OVERLAY 2848
- 5714188 TESTER OVERLAY 2701 - PDA
- 5724376 TESTER OVERLAY 2250 II
- 5740506 TESTER OVERLAY 2701 - TA I
- 5740508 TESTER OVERLAY 2701 - TA II
- 5740509 TESTER OVERLAY 2701 - TTY I
- 5740511 TESTER OVERLAY 2701 - TTY II
- 5750869 TESTER OVERLAY 2701 - TA III
- 5750870 TESTER OVERLAY 2701 - SDA I
- 5771914 TESTER OVERLAY 2250 III
- 8029740 TESTER OVERLAY 2671 - 2822
- 634429 TESTER OVERLAY 360 I/O 1442
- 5740551 TESTER OVERLAY 360 I/O,
2701/TTY II

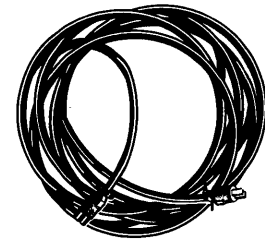

460261 CORD ASM., TELE., 2
PRONG, 40 FEET
2108538 ADAPTER CABLE, SOUND
POWER PHONE, 12 FEET,
1070

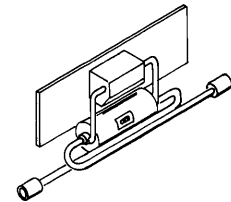

- 5488710 R/C NETWORK,
PRE AMP, LOW
- 5488711 R/C NETWORK,
PRE AMP, NORMAL
- 5488712 R/C NETWORK,
PRE AMP, HIGH
50

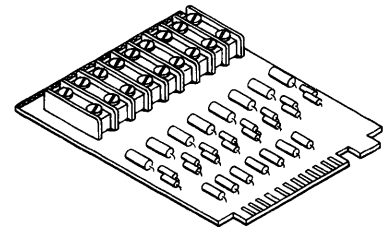

1550709 CARD ASM, CE D.I. CONTACT
1550710 CARD ASM, CE D.O.
CONNECTOR SYS 7

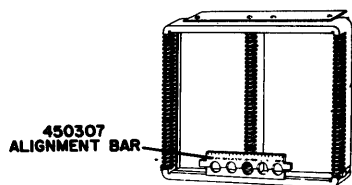

450307 ALIGNMENT BAR
450323 DOUBLE PANEL GAGE ASM.

**450323 GAUGE ASM, CONTROL PANEL, DOUBLE, 276 X 324 MM
450307 ALIGNMENT BAR

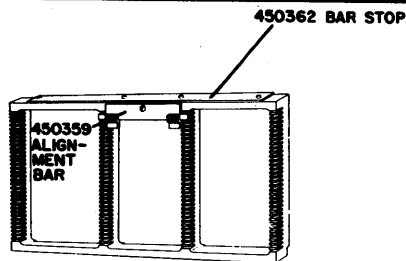

450362 BAR STOP
450354 TRIPLE PANEL GAGE ASM.



450579 TRIPLE PANEL GAGE ALIGNMENT BAR

450354 GAUGE ASM, CONTROL PANEL, TRIPLE, 276 X 479 MM
450359 ALIGNMENT BAR
450579 ALIGNMENT BAR, FOR SELF-CONTACT OR ALUMINUM PANEL

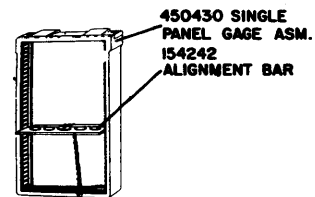

450430 SINGLE PANEL GAGE ASM.
154242 ALIGNMENT BAR

** 450430 GAUGE ASM, CONTROL PANEL SINGLE, 159 X 270 MM
154242 ALIGNMENT BAR

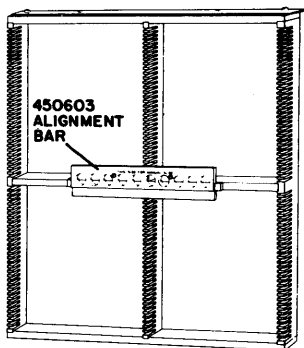

450603 ALIGNMENT BAR
450601 CONTROL PANEL GAGE-407

** 450601 GAUGE ASM, CONTROL PANEL, 407, 505 X 556 MM
450603 ALIGNMENT BAR

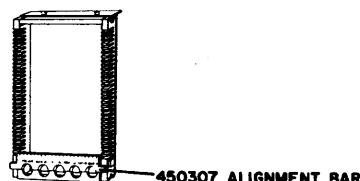

450604 CONTROL PANEL GAGE-604
450307 ALIGNMENT BAR

450604 GAUGE ASM, CONTROL PANEL, 604, 169 X 276 MM
450307 ALIGNMENT BAR

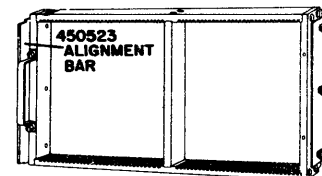

450523 ALIGNMENT BAR
450531 CONTROL PANEL GAGE-101

**450531 GAUGE ASM, CONTROL PANEL, 101, 286 X 505 MM
450523 ALIGNMENT BAR

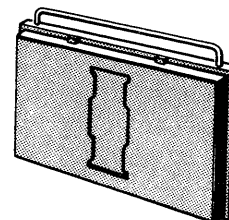

** 450678 PANEL, TEST CONTROL, 407
450681 PANEL ASSEMBLY, TEST CONTROL 407
** 451538 PANEL, TEST CONTROL, 407 E4
451537 PANEL ASSEMBLY, TEST CONTROL 407
** 451099 PANEL, TEST CONTROL, 108
451100 PANEL ASSEMBLY, TEST CONTROL, 108 E4
460178 PANEL, TEST CONTROL 604/521
* 325410 PANEL, TEST CONTROL 7C01, 7500
* 352411 PANEL, TEST CONTROL, 7550
* 352412 PANEL, TEST CONTROL, 7P01, 7400
* 352414 PANEL TEST CONTROL, 7C03, 7500
* 352415 PANEL, TEST CONTROL, 7R03, 7550

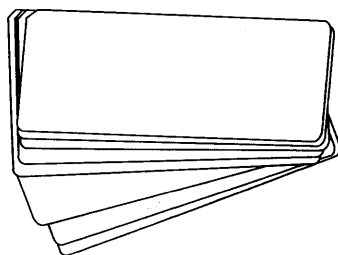

450680 DECK, TEST 463 CARDS 407 E4
450683 DECK, TEST 402
451103 DECK, TEST 108
452910 DECK, TEST 4M60
DIAGNOSTIC PROGRAM 1026
452913 DECK, TEST 1026
2528888 DECK, TEST MARK SENSE 2222

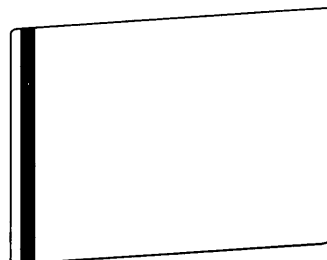

9900217 CARD, MAGNETIC LEDGER, MASTER 6400

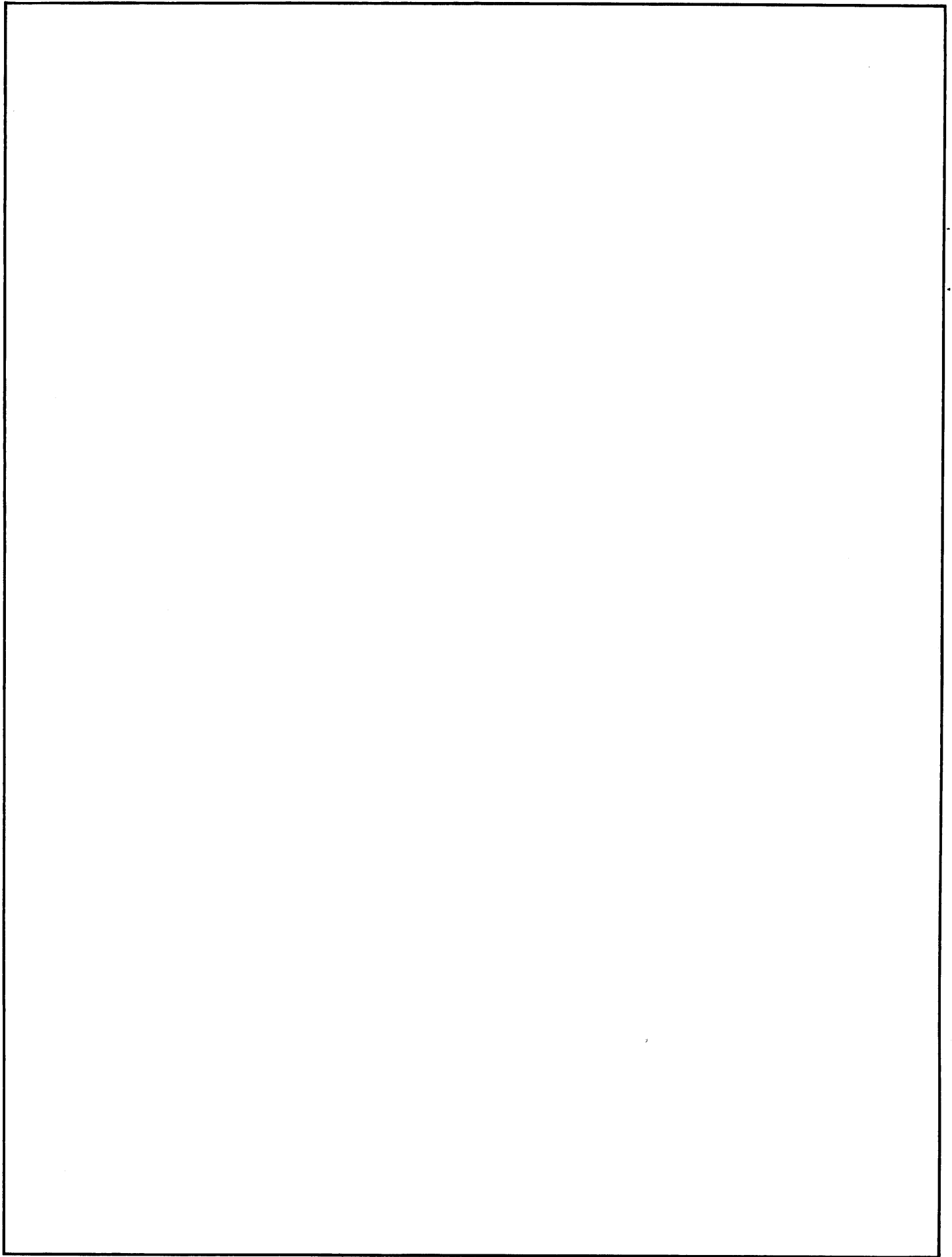

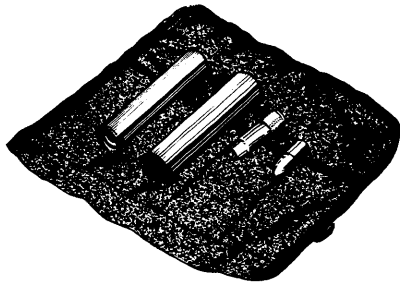

450568 KIT ASSEMBLY, OIL SEAL

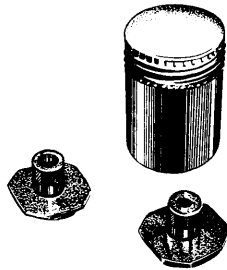

454337 KIT, EMITTER GAGE

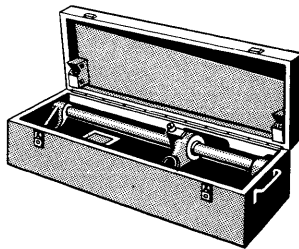

** 2108433 KIT, DISK ALIGNING, 1301

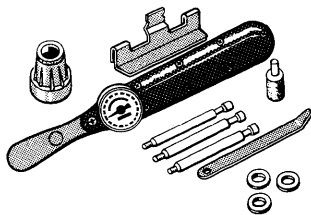

2108268 KIT, DISK REPLACEMENT, 1405
 CONSISTING OF
 45740 WASHER 3/8
 2108027 DISK INSTALLING TOOL
 2108040 ADAPTER, SOCKET WRENCH
 3/8 SQ DR, 5/16 HEX
 2108041 BOLT, 3/8-24, PULLDOWN,
 SPL.
 2108051 TIP, CLUTCH
 2108314 CLAMP, DISK POSITIONING
 2108570 DISK ALIGNING TOOL

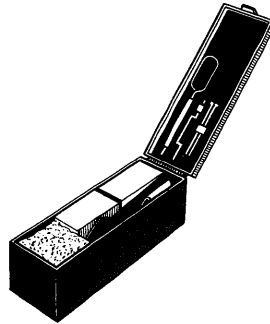

352465 KIT ASM, TAPE CLEANER
 CONSISTING OF
 352466 BOX, CLEANER
 352561 DECAL, CLEANING
 INSTRUCTION
 352605 FELT PADS PACKAGE
 352606 PAD HOLDER
 556944 Q - TIPS
 556945 BRUSH, CLEANER 2 1/2"
 NYLON
 1018992 BRUSH, TAPE CLEANING
 2108930 CLOTH, LINT FREE 9 X 9
 2507587 PROBE, 1/8" X 4 1/2"
 NYLON
 2513590 BRUSH, TAPE PATH
 CLEANING

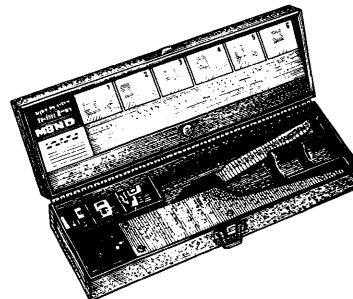

461038 DIE SET, CRIMP,
 BURNDY N22R VT-1
 461121 DIE SET, CRIMP,
 BURNDY N12RT-3
 461122 DIE SET, CRIMP,
 BURNDY N12ECT
 461036 CRIMPING TOOL,
 HANDLE,
 BURNDY M8ND



2108311 KIT ASM, HEAD CLEANING
 350/355 CONSISTING OF
 451554 ADJUSTING TOOL, VARIABLE
 INDUCTOR
 2108014 TWEEZERS, SELF-CLOSING
 2108024 PLATE, TEST, 2 X 2 X .10,
 PLASTIC
 2108025 BRUSH, ACID, NO. 2
 2108036 PAPER, WATCHMAKERS,
 3 X 3 IN.
 2108055 SOLVENT, ALCOHOL, BOTTLE
 2108075 LEAF, GRAM GAGE, 65G
 2108312 BOX, PLASTIC, 6 X 6 X 2 IN.
 2108313 CAS
 2108313 CASE, TOOL, PLASTIC

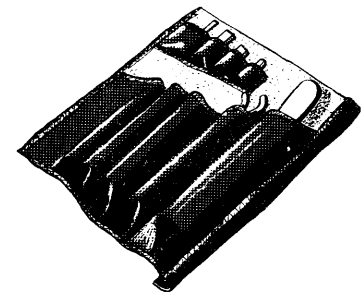

2108470 KIT, TORQUE WRENCH AND
 ACCESSORIES
 2108435 WRENCH
 2108436 ADAPTER
 2108466 SOCKET, UNIVERSAL
 2108478 SOCKET, 0.375 IN.
 2108481 ROLL, TORQUE TOOL KIT
 2108486 SOCKET, 0.125 IN.
 2108746 ADAPTER SOCKET
 2108747 SOCKET, 0.078 HEX BIT

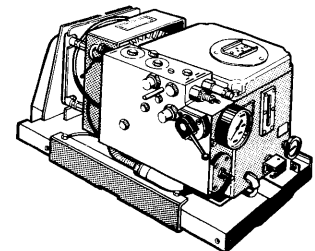

2121874 HYD POWER SUPPLY
 REPLACEMENT KIT

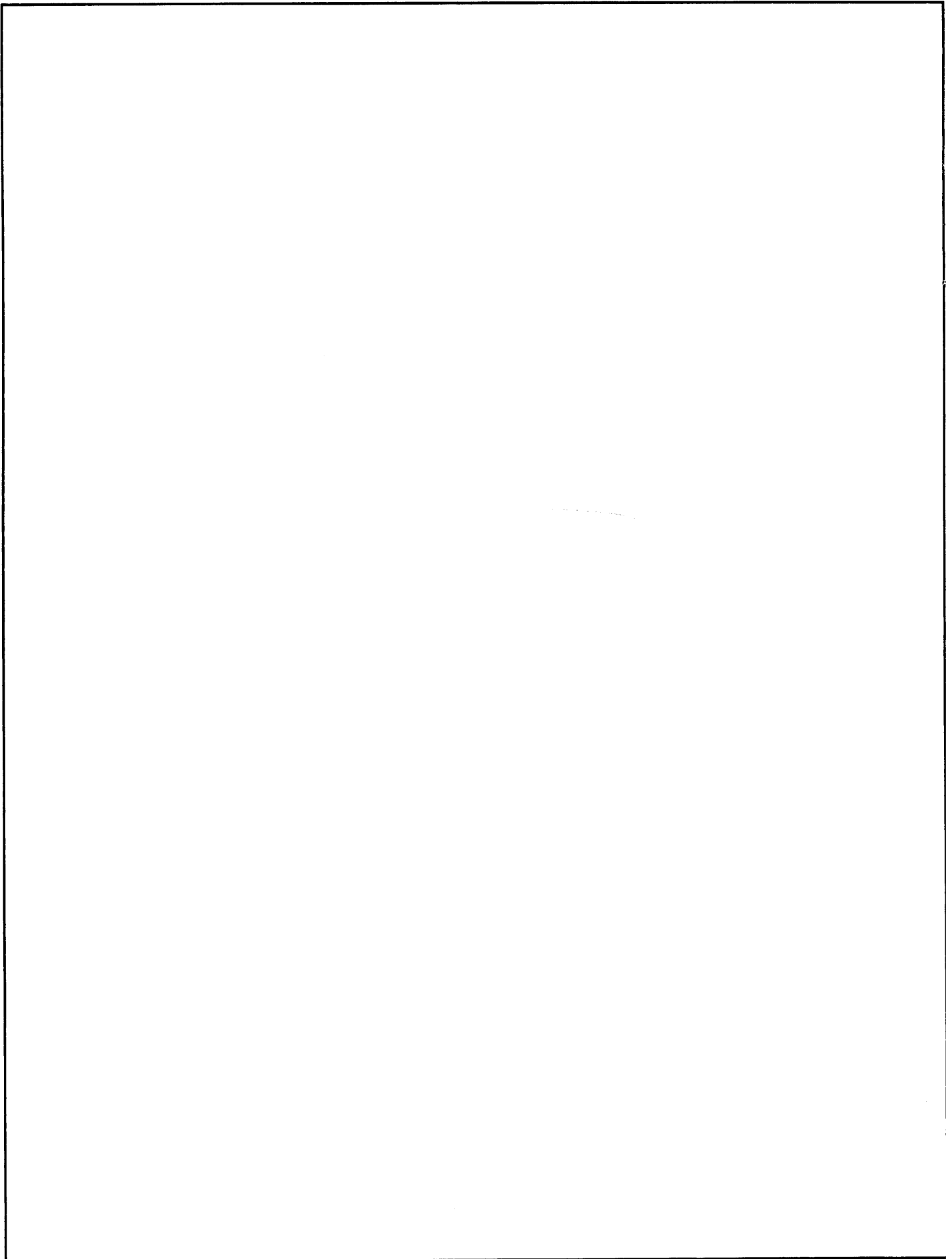

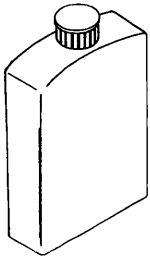

9900049. BOTTLE AND CAP,
WITHOUT LABEL

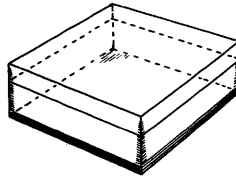

* 6514016 PLASTIC BOX

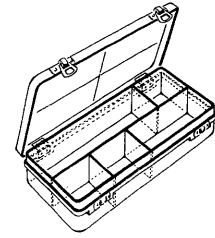

450465 BOX, PLASTIC, 5 SECT,
9 X 4 X 1.5 IN.

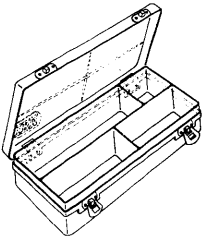

* 4261088 BOX, PLASTIC, 9 X 4 X 1 IN.

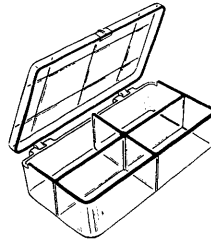

454352 BOX, PLASTIC, 4 SECT,
5 X 3 X 1 IN.

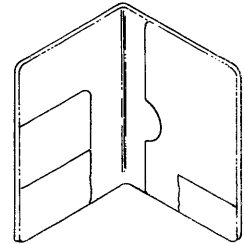

453594 FOLDER, WALLET TYPE

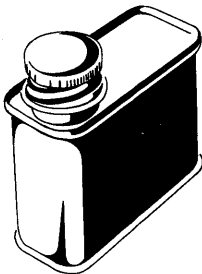

454328 CAN, EMPTY, 4 OZ.
SCREW TOP



450639 BOTTLE, 2 OZ, SQUARE, PLASTIC
450658 CAP, PLASTIC, BOTTLE

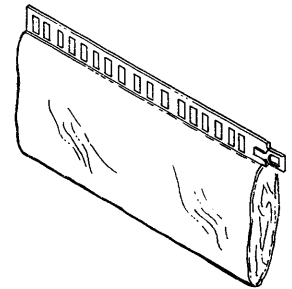

855546 HOLDER, SPECIAL TOOLS

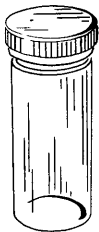

TUBE AND CAP, PLASTIC
450638 13/16 X 2-1/8 IN.
450637 7/8 X 2-1/2 IN.

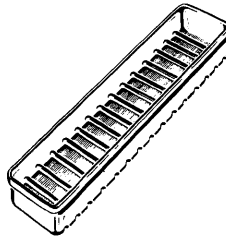

* 4261069 WASHING TRAY



* 451652 TOOL CASE, CUST.
INSTALLATION



450861 CARRYING CASE,
SCOPE TYPE 310

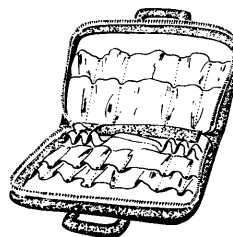

* 454351 TOOL BAG WITH ZIP,
OLD STYLE, 10.5 X 12.5 IN.

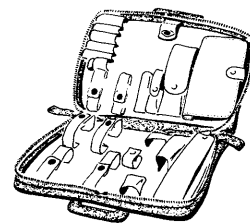

* 4261104 TOOL BAG WITH ZIP,
11 X 17 IN.

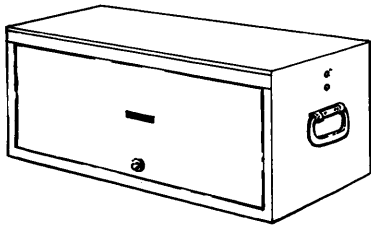

* 701329 CHEST, PARTS
AUTO TRUNK

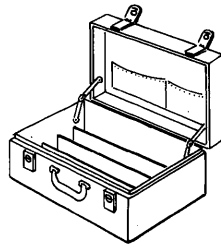

*4261062 CASE, SMS CARDS

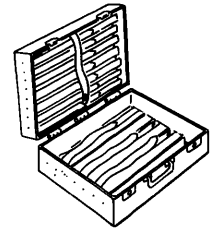

*4261114 CASE, SLT CARDS

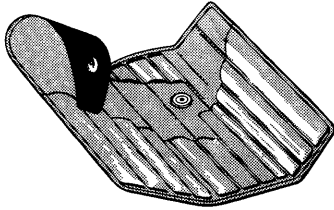

*4261089 PLASTIC CASE,
DRILL SET

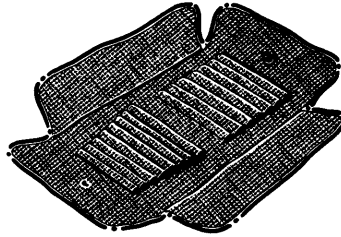

450467 CASE CANVAS,
SOCKET KEYS

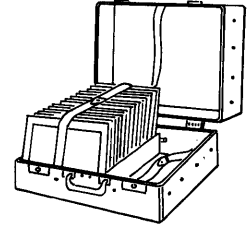

*4261147 CASE, MST CARDS

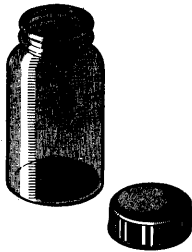

460996 BOTTLE, BROWN GLASS
8 OZ., WIDE MOUTH

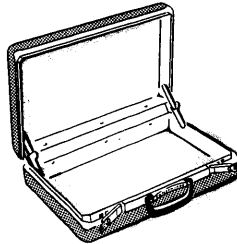

*4261102 TOOL CASE

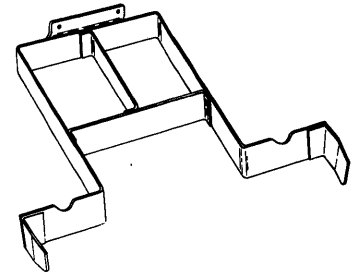

*4261148 FRAME INSERT, TOOL CASE

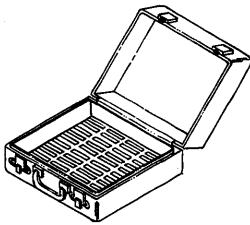

453560 CARD CADDY B/M
453561 STORAGE CASE
453562 CONTAINER, CARD
SHIPPING

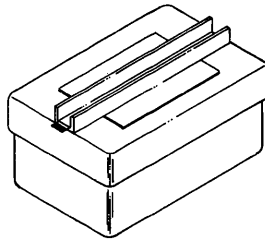

2114417 PAN, OIL DRAIN-
COMPRESSOR

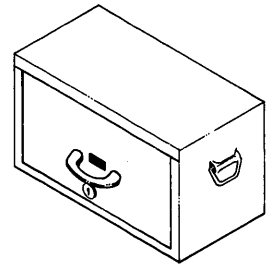

453513 CHEST, AUTO TRUNK, LARGE

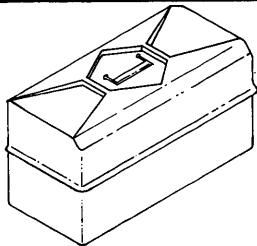

9900371 CHEST, AUTO TRUNK,
PLASTIC, SMALL

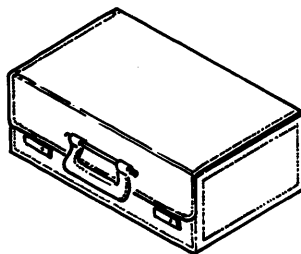

963400 CARD CADDY

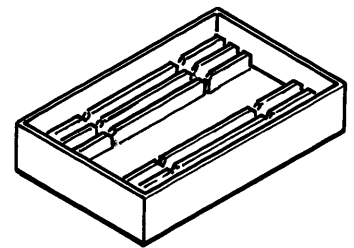

2728154 BOX - MST 4W 2H CARDS

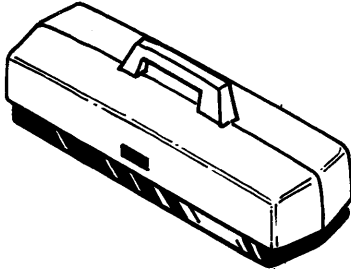

2646290 CARRYING CASE, 3216

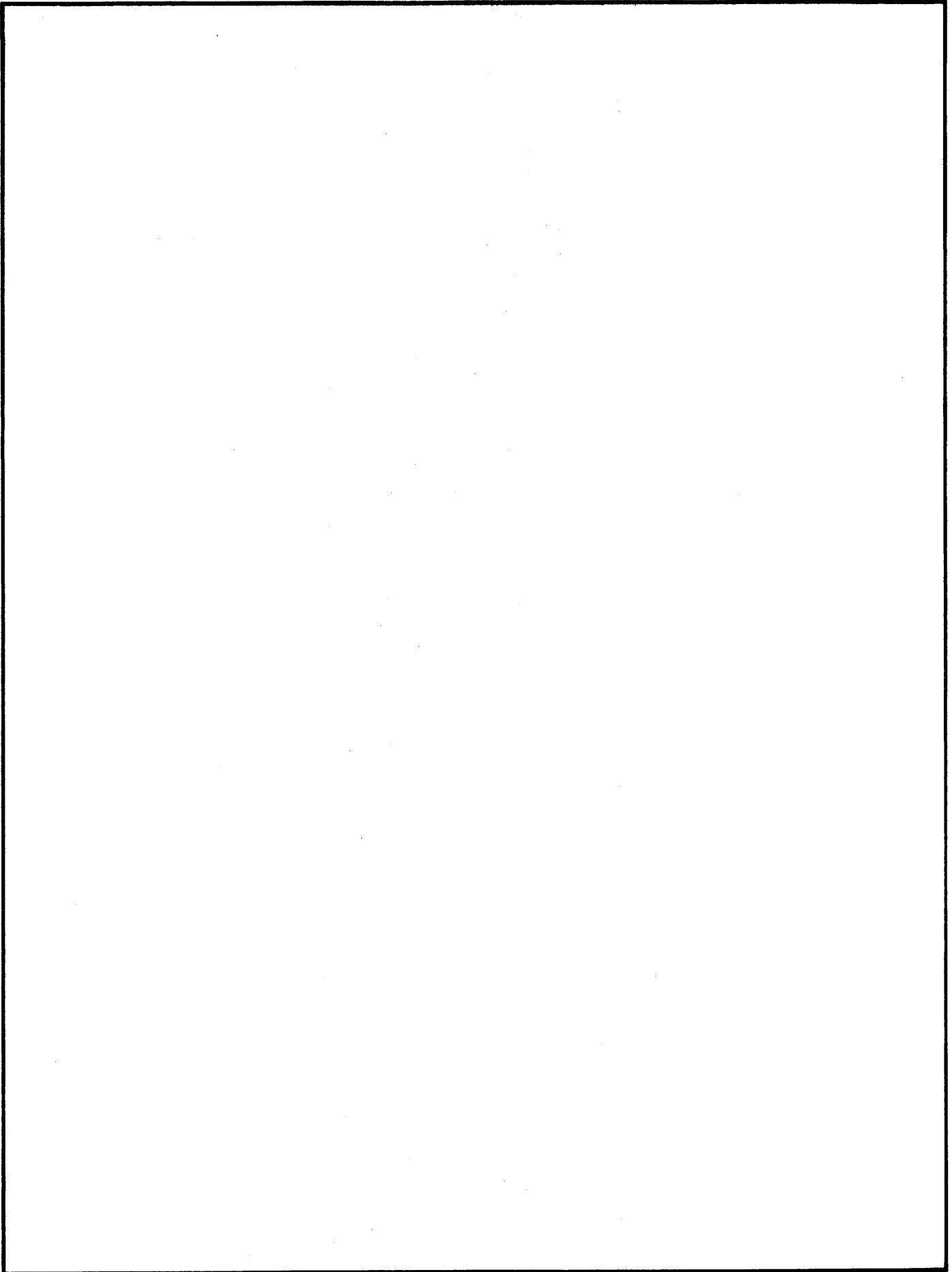

FIELD SUPPLIES (Lubricants, Adhesives, etc.)

- | | | |
|-----------|--|------|
| 104774 | ADHESIVE, RUBBER CEMENT, 3M-EC 847 | |
| 261096 | ADHESIVE, 3M-826, 5 OZ TUBE | |
| 289318 | ADHESIVE, GLYPHAL, 1201B | |
| 450450 | ADHESIVE, PERMATEX SEALANT | |
| 452396 | ADHESIVE, EPOXY KIT | |
| 603910 | ADHESIVE, RUBBER CEMENT, 3M-EC 2262 | |
| 605960 | ADHESIVE, LOCITE SEALANT, TYPE E | |
| 615960 | ADHESIVE, LOCQUIC PRIMER SEALANT | |
| 628969 | ADHESIVE, EASTMAN 910 | |
| 2175928 | ADHESIVE, LOCITE SEALANT, TYPE H | |
| 5320042 | ADHESIVE, PIX MIX EPOXY | |
| 5715009 | APRON, SYNTHETIC RUBBER | |
| 5246316 | BLOCK, CLEANING | 7320 |
| 453638 | BAG, PLASTIC - 3 IN X 4 IN | |
| 453639 | BAG, PLASTIC - 4 IN X 6 IN | |
| 453640 | BAG, PLASTIC - 12 IN X 18 IN | |
| 453641 | BAG, PLASTIC - 8-1/2 IN X 17 IN | |
| 453642 | BAG, PLASTIC - 6 IN X 9 IN | |
| 453643 | BAG, PLASTIC - 4 IN X 6 IN | |
| 453559 | BINDER, 6 RING BLUE | |
| 2513590 | BRUSH, CLEANING | 2420 |
| 5715008 | CAPE, RAWHIDE | |
| 834286 | CEMENT KIT | |
| 2248078 | CLOTH, BLACK FOCUSING | |
| 451686 | CHART, PAPER, AC RECORDING | |
| 460296 | CLOTH, DROP, OIL PROOF | |
| 619022 | DEGREASER, AEROSOL CAN | |
| 453522 | DEVELOPING SOLUTION, 1/2 PT FOR 453505 | |
| 5392438 | FLUX, 2 OZ - BROWN | |
| 2200032 | FREON, PCA, CLEANING AGENT | |
| 5715011 | GLOVES LINEMAN'S SIZE 11 | |
| 2200041 | GLOVES, PLASTIC | |
| 337539 | GREASE - SILICONE | |
| 265390 | GREASE - SILICONE, TUBE | |
| 461621 | GLOVES, NYLON, LINT-FREE | |
| 2115252 | HYDRAULIC OIL, GAL | |
| 2164584 | HYDRAULIC OIL, QT | |
| 5715010 | HEADGEAR, WITH WINDOW = 18-1/4 X 10 X .06 | |
| 453558 | HOLDER | |
| 5392435 | HUMISEAL, 2 OZ. - BROWN | |
| 451125 | HOLDER, MACHINE PERFORMANCE RECORD | |
| 460896 | INK, VITREOUS MARKING, WHITE, 1 OZ | |
| 1280017 | IBM CLEANING FLUID, 1 GAL | |
| 2508924 | KIT, OPTICAL CLEANING | 2680 |
| 454355 | LACQUER, GRAY, TOUCHUP, 12 OZ SPRAY | |
| 603716 | LACQUER, LIGHT GRAY, TOUCHUP, 823, 12 OZ SPRAY | |
| 603717 | LACQUER, BLACK, TOUCHUP, 825, 12 OZ SPRAY | |
| 603718 | LACQUER, DP CHARCOAL, TOUCHUP, 828, 12 OZ SPRAY | |
| 634779 | LACQUER, DULL WHITE, TOUCHUP, 815, 12 OZ SPRAY | |
| 2108180 | LACQUER, GRAY ACRYLIC, TOUCHUP, 803, 6 OZ SPRAY | |
| 2108181 | LACQUER, GRAY ACRYLIC, TOUCHUP, 804, 6 OZ SPRAY | |
| 2108184 | LACQUER, BLK ACRYLIC, TOUCHUP, 805, 6 OZ SPRAY | |
| 2108721 | LACQUER, DP CHARCOAL, TOUCHUP, 812, 12 OZ SPRAY | |
| 2108722 | LACQUER, SMS BLUE, TOUCHUP, 827, 12 OZ SPRAY | |
| 2108723 | LACQUER, SUN YELLOW, TOUCHUP, 829, 12 OZ SPRAY | |
| 2108724 | LACQUER, FLAME RED, TOUCHUP, 836, 12 OZ SPRAY | |
| 450109 | LABEL, JAR | |
| 2200118 | LIQUID, ANTI-STATIC | 2314 |
| 173488 | LUBRICANT, NO. 2, 1/4 OZ WATCH OIL | |
| 477567 | LUBRICANT, NO. 3, HYDRAULIC OIL, GAL | |
| 450669 | LUBRICANT, NO. 4, PT | |
| 450670 | LUBRICANT, NO. 4 QT | |
| 223980 | LUBRICANT, NO. 6 PT | |
| 450315 | LUBRICANT, NO. 6, GAL | |
| 451110 | LUBRICANT, NO. 6, SPRAY, 6 OZ CAN | |
| 2127714 | LUBRICANT, NO. 7, COMPRESSOR OIL, PT | |
| 450668 | LUBRICANT, NO. 9 QT | |
| 450676 | LUBRICANT, NO. 9 QT | |
| 450133 | LUBRICANT, NO. 12, QT | |
| * 771627 | LUBRICANT, NO. 12, ONE LITER CAN | |
| 450052 | LUBRICANT, NO. 15, QT | |
| 450238 | LUBRICANT, NO. 15, PT | |
| 450556 | LUBRICANT, NO. 17, LB | |
| * 771821 | LUBRICANT, NO. 17, 200 GRAM TUBE | |
| 117397 | LUBRICANT, NO. 20, LB | |
| * 771674 | LUBRICANT, NO. 20, 100 GRAM TUBE | |
| 260781 | LUBRICANT, NO. 22, LB | |
| * 771625 | LUBRICANT, NO. 22, 100 GRAM TUBE | |
| 1280441 | LUBRICANT, NO. 23, 1/2 OZ TUBE | |
| 1280442 | LUBRICANT, NO. 23, 1 LB CAN | |
| 450633 | LUBRICANT, NO. 24, LB | |
| 451053 | LUBRICANT, CARD CONTACT, 4 OZ CAN | |
| 471519 | LUBRICANT, DRUM BEARING, 1 LB .45 KILO | |
| 2127794 | LUBRICANT, GREASE, NO. 3, SHAFT MOTOR, LB | |
| 2133355 | LUBRICANT, LB 300 X OIL, PT | |
| 435682 | LUBRICANT, LUBRIPLATE NO. 70, PT | |
| 453391 | LUBRICANT, PIN | |
| 357830 | MOLYCOTE TYPE G | |
| * 771494 | MOLYCOTE 350B, 10 GRAM TUBE | |
| * 771847 | MOLYCOTE BR2, 100 GRAM CAN | |
| 1280018 | MOLYCOTE, TUBE | |
| 5144304 | MOLYCOTE G RAPID, 2 OZ | |
| * 8026752 | MOLYCOTE, 1LB | |
| * 352407 | MARKER, MAGNETIC TAPE | |
| 596338 | OIL, TRANSFORMER 55 GAL. | 7302 |
| 856381 | OIL CARTRIDGE LUBRICANT | |
| 2115444 | OIL-CLOCK MOTOR, 1 OZ, 28,3 GRAMS | |
| 1280443 | OIL IBM 10, 4 OZ CAN | |
| 1280444 | OIL IBM 10, 1PT CAN | |
| 450936 | PLASTIC SPRAY, 12 OZ | |
| * 771754 | PLEXIKLAR, CLEANING FLUID ANTISTATIC, 100 GRAM B | |
| 641458 | PAINT, SILVER CONDUCTIVE | |
| 461305 | RIBBON, CLEANING | 557 |
| 216348 | SEALANT, LOCITE TYPE A, 2 CC TUBE | |
| 450405 | SKIN CREME, MONO DERMIN, 50 GRAM TUBE | |
| 289273 | SMOCK, SMALL | |
| 289274 | SMOCK, MEDIUM | |
| 289275 | SMOCK, LARGE | |
| 346986 | SEALER, ZIPPERTUBING 1 OZ | |
| 5480396 | SEALANT, CLEAR-2 CC CAPED TUBE | 50 |
| 889524 | SEALANT, SILICONE-RUBBER ADHESIVE | |
| 2106774 | SOLVENT, LETTERING | |
| 450608 | SOLVENT, IBM CLEANING, 6 OZ CAN | |
| 450700 | SOLVENT, COVER STAIN REMOVER, 4 OZ BOTTLE | |
| 450891 | SOLVENT, CLEANER, COVER, 8 OZ CAN | |
| 2200200 | SOLVENT 91% ISOPROPYL ALCOHOL, 6 OZ BOTTLE | |
| 5246313 | SOLVENT, CLEANER | |
| 641462 | SOLDER PASTE 50-50 | |
| 353887 | SOLDER, ROSIN CORE | 7302 |
| 2134643 | SOLDER FLUX, FOR #2134618 LOW TEMP SOLDER | |
| 2155966 | SOLVENT, ALCHOL, ISOPROPYL, 9%, PINT | |
| 9900050 | SPONGE, CLEANING | |
| 2200043 | TAPE, GREEN, STRIP HOUSING | 2321 |
| 303820 | TAPE, PLASTIC ELECT, 1/2 IN. X 36 YDS., BLK | |
| 114050 | TAPE, FRICTION, 3/4 IN X 1/2 LB | |
| 241663 | TAPE, PRESSURE SENSITIVE, PRINTABLE, 3/8 IN | |
| 322386 | TAPE, SPLICING, MAGNETIC TAPE, 1/2 IN | |
| 450692 | TAPE, PLASTIC ELEC, 3/4 IN X 20 FT | |
| 450695 | TAPE, FRICTION, 3/4 IN X 45 FT | |
| 451545 | TAPE, FILAMENT, 3/4 IN 36 YD ROLL | |
| 451546 | TAPE, MASKING, PAPER, 1 IN | |
| 596763 | THREAD SEALANT | |
| 308882 | VINYL, AVCLAD, TOUCHUP, 7/8 X 5 IN TUBE | |
| 450701 | WAX EMULSION | |
| 5442867 | CAP, SAFETY W/LINER | |
| 5442868 | REPLACEMENT LINER FOR 5442867 | |

CONVERSION TABLE

1 OZ (ounce)	=	28.3 Grams
1 LB (pound)	=	.45 Kilogram
1 PT (pint)	=	.5 Liter
1 QT (quart)	=	.9 Liter
1 GAL (gallon)	=	3.8 Liters
1 IN (inch)	=	25.4 MM

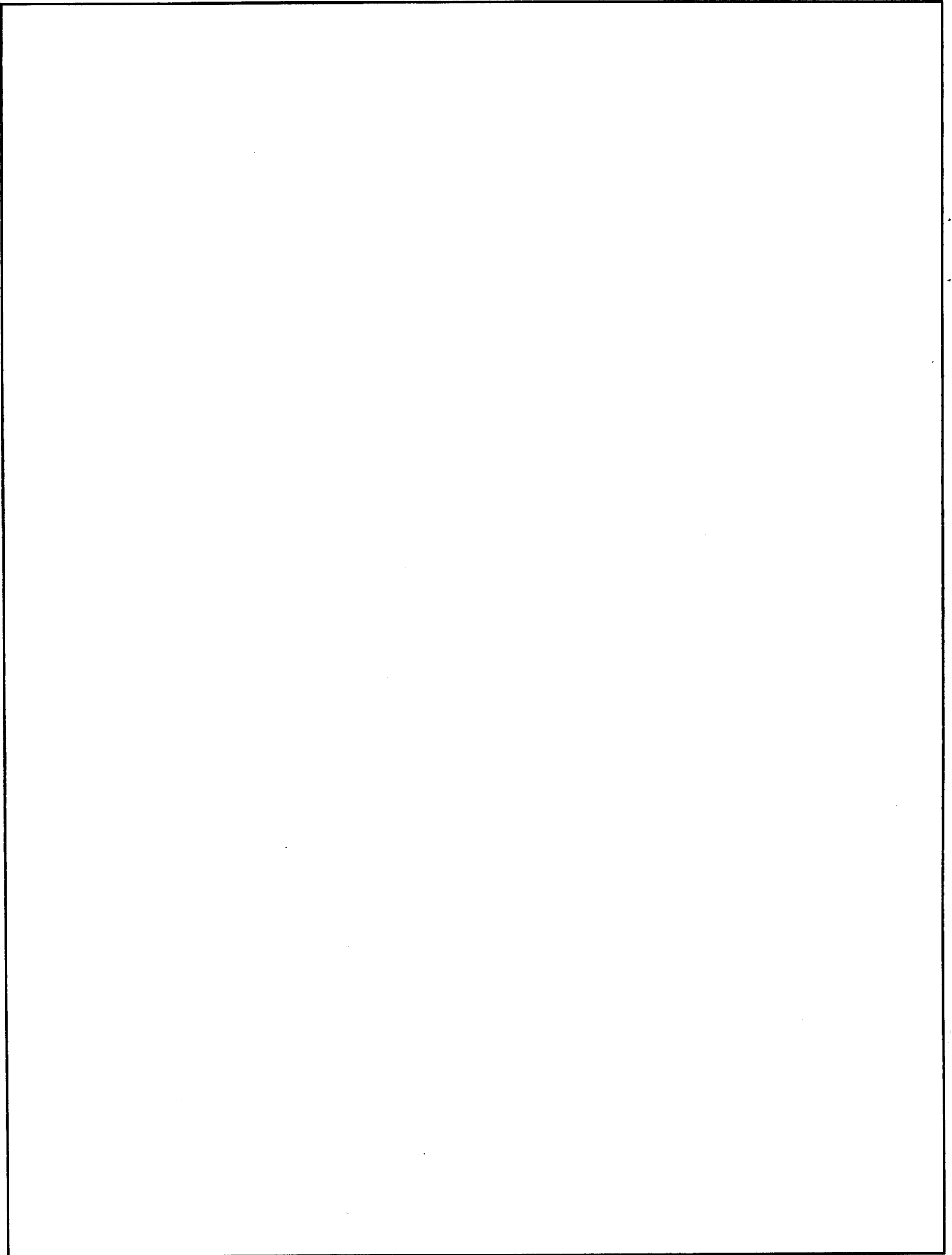

NUMERICAL INDEX

PART NO.	GROUP AND PAGE NO.	PART NO.	GROUP AND PAGE NO.	PART NO.	GROUP AND PAGE NO.	PART NO.	GROUP AND PAGE NO.
3339	10 - 45	11234	8 - 27	152831	9 - 41	173258	2 - 8
3339	1 - 3	18463	6 - 21	152857	3 - 12	173259	2 - 8
3339	1 - 5	18463	1 - 3	153690	3 - 9	173260	2 - 7
3497	10 - 46	18463	1 - 5	153690	3 - 9	173261	2 - 7
3577	17 - 71	18974	6 - 22	153691	3 - 9	173262	2 - 7
3701	11 - 51	18974	1 - 3	153691	3 - 9	173488	23 - 95
3986	2 - 7	18974	1 - 5	153692	3 - 9	173993	3 - 9
3987	2 - 7	18975	6 - 21	153692	3 - 9	173993	3 - 10
3988	2 - 7	18975	1 - 3	153693	3 - 9	173994	3 - 9
3989	1 - 3	18975	1 - 5	153693	3 - 9	173994	3 - 9
3989	2 - 7	21213	3 - 11	153694	4 - 16	173995	3 - 9
3990	2 - 7	21213	1 - 5	153694	1 - 3	173995	3 - 9
3991	1 - 3	45740	21 - 91	153694	1 - 5	176088	10 - 45
3991	2 - 7	55746	2 - 8	153696	4 - 16	178397	3 - 13
3992	2 - 7	55747	2 - 8	153696	1 - 5	178397	3 - 12
3993	2 - 7	55748	2 - 8	153697	4 - 16	178577	4 - 16
3994	2 - 7	55750	2 - 8	153697	1 - 3	178577	1 - 3
3995	2 - 7	55753	2 - 8	153697	1 - 5	178577	1 - 5
3996	1 - 3	55754	2 - 8	153698	4 - 16	178666	2 - 7
3996	2 - 7	55755	2 - 8	153698	1 - 3	178667	2 - 8
3997	2 - 7	55757	2 - 8	153698	1 - 5	202911	8 - 30
3998	2 - 7	55759	2 - 8	153701	3 - 9	206913	19 - 83
3999	2 - 7	55760	2 - 8	153701	3 - 11	206914	19 - 83
4000	2 - 7	55761	2 - 8	153702	3 - 9	206916	19 - 83
4001	2 - 7	55762	1 - 3	153702	3 - 11	210860	19 - 83
4002	2 - 7	55762	2 - 7	153703	3 - 9	216348	23 - 95
4003	2 - 7	55763	2 - 7	153703	3 - 11	220710	8 - 31
4004	2 - 7	55764	2 - 7	153704	3 - 9	221244	3 - 10
4005	2 - 7	55766	2 - 7	153704	3 - 11	223980	23 - 95
4006	2 - 8	55767	1 - 3	153705	3 - 9	224036	7 - 25
4007	2 - 8	55767	2 - 7	153705	3 - 11	228993	10 - 46
4008	2 - 8	55769	1 - 3	153706	3 - 9	231034	8 - 33
4008	1 - 3	55769	2 - 7	153706	3 - 11	241663	23 - 95
4009	2 - 8	55770	2 - 7	153778	12 - 53	253826	9 - 41
4009	1 - 3	55771	2 - 7	154230	7 - 24	256341	19 - 83
4010	2 - 8	55773	2 - 7	154230	1 - 3	256342	19 - 83
4010	1 - 3	55781	2 - 7	154230	1 - 5	259746	8 - 35
4011	6 - 22	55782	2 - 7	154242	20 - 89	260781	23 - 95
4011	1 - 3	55797	2 - 8	154292	2 - 7	261096	23 - 95
4011	1 - 5	55797	1 - 3	154365	2 - 7	265390	23 - 95
4013	1 - 5	55798	2 - 8	157189	7 - 26	289273	23 - 95
4013	6 - 21	55799	2 - 8	157199	7 - 26	289274	23 - 95
4013	1 - 3	55799	1 - 3	157200	7 - 26	289275	23 - 95
4014	6 - 21	55800	2 - 8	157919	2 - 8	289318	23 - 95
4014	1 - 3	55800	1 - 3	157920	2 - 8	302132	8 - 36
4014	1 - 5	55864	13 - 55	158220	2 - 8	303820	23 - 95
4028	5 - 17	58284	8 - 30	158333	8 - 27	308882	23 - 95
4028	1 - 3	74530	16 - 67	158333	1 - 3	313738	18 - 79
4028	1 - 5	74530	16 - 67	158333	1 - 5	322386	23 - 95
4029	5 - 17	74530	16 - 67	158333	1 - 5	322992	19 - 81
4031	7 - 25	74530	16 - 67	158602	8 - 28	325410	20 - 89
4031	1 - 3	74530	16 - 67	158603	8 - 28	332009	17 - 71
4031	1 - 5	74925	3 - 12	158644	2 - 8	337539	23 - 95
4032	7 - 26	74925	3 - 13	158645	12 - 53	338165	17 - 71
4032	1 - 3	76104	1 - 3	158645	1 - 3	343641	5 - 17
4032	1 - 5	76104	1 - 5	158645	1 - 5	346986	23 - 95
4035	7 - 26	77009	3 - 12	158759	2 - 8	348590	19 - 88
4035	1 - 3	77009	3 - 13	158765	3 - 9	348591	19 - 88
4035	1 - 5	104774	23 - 95	158765	3 - 11	352407	23 - 95
4045	3 - 10	105668	8 - 27	158766	3 - 9	352411	20 - 89
4046	7 - 26	105668	1 - 5	158766	3 - 11	352412	20 - 89
4047	7 - 25	111256	17 - 71	158799	2 - 7	352414	20 - 89
4047	1 - 3	111261	17 - 71	158829	12 - 54	352415	20 - 89
4047	1 - 5	111264	17 - 71	158955	6 - 22	352465	21 - 91
4050	4 - 15	112646	3 - 12	165584	3 - 13	352465	11 - 52
4050	1 - 5	114050	23 - 95	165584	3 - 12	352466	11 - 52
4055	13 - 56	116574	3 - 12	165584	1 - 5	352561	11 - 52
6325	17 - 71	116574	3 - 13	165866	6 - 21	352605	21 - 91
7231	3 - 13	117397	23 - 95	165866	1 - 3	352605	11 - 52
7231	3 - 12	123228	8 - 27	165866	1 - 5	352606	21 - 91
8955	2 - 8	123635	8 - 27	167717	2 - 7	352606	11 - 52
8956	2 - 8	123789	3 - 12	167718	2 - 8	353887	23 - 95
8957	2 - 8	124660	19 - 81	171307	2 - 8	357830	23 - 95
8957	1 - 3	129111	10 - 46	171308	2 - 7	363480	9 - 42
8958	2 - 8	129118	10 - 46	171320	7 - 24	370421	15 - 61
10407	10 - 45	150246	8 - 27	171320	1 - 3	370616	15 - 61
10407	1 - 5	152759	3 - 9	171320	1 - 5	370823	15 - 61
10480	8 - 27	152759	1 - 3	171959	11 - 51	372277	16 - 67
10480	1 - 3	152759	1 - 5	173257	2 - 8	372561	15 - 61

PART NO.	GROUP AND PAGE NO.	PART NO.	GROUP AND PAGE NO.	PART NO.	GROUP AND PAGE NO.	PART NO.	GROUP AND PAGE NO.
374900	15 - 61	450182	7 - 24	450428	8 - 28	450574	9 - 41
375277	16 - 65	450224	8 - 31	450429	3 - 9	450575	9 - 41
399123	8 - 33	450224	1 - 5	450429	3 - 11	450579	20 - 89
399147	8 - 36	450236	2 - 7	450430	20 - 89	450584	8 - 28
432152	19 - 85	450237	2 - 7	450432	6 - 22	450601	20 - 89
432153	19 - 85	450238	23 - 95	450433	6 - 22	450603	20 - 89
432640	19 - 85	450253	2 - 7	450434	8 - 28	450604	20 - 89
432641	19 - 85	450256	2 - 7	450443	12 - 53	450608	23 - 95
432642	19 - 85	450257	2 - 7	450448	7 - 26	450618	10 - 46
435682	23 - 95	450258	2 - 7	450448	1 - 3	450619	4 - 15
440140	17 - 72	450259	2 - 7	450448	1 - 5	450619	1 - 3
442618	8 - 31	450262	16 - 64	450450	23 - 95	450619	1 - 5
450001	2 - 8	450262	2 - 7	450451	10 - 45	450626	7 - 24
450002	2 - 7	450263	1 - 3	450453	3 - 13	450633	23 - 95
450008	2 - 8	450263	2 - 7	450453	3 - 12	450634	10 - 46
450011	2 - 8	450264	2 - 7	450454	3 - 13	450637	22 - 93
450014	12 - 53	450265	2 - 7	450454	3 - 12	450637	1 - 5
450017	2 - 8	450269	2 - 8	450455	3 - 12	450638	22 - 93
450022	10 - 45	450270	1 - 8	450456	7 - 26	450638	1 - 3
450022	1 - 5	450270	1 - 3	450457	7 - 26	450638	1 - 5
450030	7 - 24	450272	2 - 7	450458	14 - 59	450639	22 - 93
450037	2 - 7	450273	2 - 8	450458	1 - 5	450640	12 - 54
450038	3 - 13	450277	2 - 7	450459	9 - 41	450657	13 - 55
450038	3 - 12	450278	2 - 7	450459	1 - 3	450658	22 - 93
450042	3 - 13	450279	2 - 7	450459	1 - 5	450660	14 - 59
450042	3 - 12	450280	2 - 7	450459	1 - 5	450660	1 - 5
450043	3 - 13	450287	2 - 7	450465	22 - 93	450668	23 - 95
450043	3 - 12	450288	2 - 8	450465	1 - 3	450669	23 - 95
450047	2 - 7	450289	2 - 7	450465	1 - 5	450670	23 - 95
450048	2 - 7	450290	1 - 3	450465	1 - 5	450674	8 - 31
450050	3 - 13	450290	2 - 7	450465	1 - 5	450676	23 - 95
450050	3 - 12	450291	2 - 7	450466	3 - 13	450678	20 - 89
450052	23 - 95	450294	2 - 8	450466	1 - 3	450679	19 - 84
450054	7 - 23	450295	2 - 8	450466	1 - 5	450680	20 - 89
450054	1 - 3	450296	2 - 8	450467	22 - 94	450681	20 - 89
450054	1 - 5	450298	2 - 7	450467	3 - 13	450683	20 - 89
450055	2 - 7	450299	2 - 7	450468	6 - 22	450684	19 - 84
450057	2 - 8	450300	2 - 7	450483	6 - 22	450686	12 - 54
450058	2 - 7	450301	2 - 7	450491	10 - 47	450692	23 - 95
450069	3 - 9	450302	2 - 7	450494	5 - 17	450694	15 - 61
450069	3 - 11	450303	2 - 7	450494	1 - 3	450694	5 - 18
450108	7 - 23	450307	20 - 89	450494	1 - 5	450694	1 - 5
450109	23 - 95	450307	20 - 89	450495	4 - 16	450695	23 - 95
450126	10 - 45	450314	13 - 55	450495	1 - 3	450700	23 - 95
450126	1 - 3	450315	23 - 95	450495	1 - 5	450701	23 - 95
450126	1 - 5	450319	6 - 22	450503	6 - 21	450713	12 - 53
450128	3 - 10	450323	20 - 89	450503	1 - 3	450713	1 - 3
450130	2 - 7	450336	2 - 8	450503	1 - 5	450713	1 - 5
450133	23 - 95	450337	2 - 7	450504	5 - 17	450714	10 - 45
450134	2 - 8	450340	10 - 46	450504	1 - 3	450716	2 - 7
450134	1 - 3	450354	20 - 89	450504	1 - 5	450717	13 - 55
450147	10 - 45	450359	20 - 89	450514	7 - 25	450721	3 - 12
450152	2 - 7	450364	8 - 31	450517	8 - 32	450722	3 - 12
450155	6 - 22	450364	1 - 5	450523	20 - 89	450732	11 - 51
450156	6 - 22	450364	1 - 5	450528	11 - 51	450732	1 - 3
450157	6 - 22	450365	7 - 23	450529	7 - 24	450732	1 - 5
450158	9 - 42	450366	8 - 28	450529	1 - 3	450743	4 - 16
450158	1 - 3	450367	8 - 31	450531	20 - 89	450744	4 - 16
450158	1 - 5	450369	2 - 7	450540	7 - 24	450745	8 - 27
450159	2 - 7	450371	2 - 7	450540	1 - 3	450745	1 - 3
450160	2 - 7	450372	3 - 12	450540	1 - 5	450745	1 - 5
450161	2 - 7	450372	3 - 13	450541	8 - 28	450756	8 - 36
450162	2 - 7	450373	3 - 12	450544	8 - 27	450757	17 - 74
450163	2 - 7	450373	3 - 13	450546	7 - 25	450758	17 - 74
450164	2 - 7	450375	2 - 8	450550	8 - 28	450759	17 - 74
450165	2 - 7	450388	8 - 28	450551	6 - 22	450778	17 - 75
450166	1 - 3	450388	1 - 5	450552	6 - 22	450785	10 - 47
450166	2 - 7	450391	7 - 26	450553	6 - 22	450786	5 - 17
450167	1 - 3	450391	1 - 3	450554	7 - 23	450787	12 - 53
450167	2 - 7	450391	1 - 5	450556	23 - 95	450802	3 - 14
450168	1 - 3	450405	23 - 95	450566	12 - 53	450813	12 - 53
450168	2 - 7	450407	7 - 26	450566	1 - 3	450813	1 - 5
450169	2 - 7	450407	1 - 3	450567	14 - 59	450814	3 - 13
450170	2 - 7	450407	1 - 5	450567	6 - 21	450814	3 - 12
450171	2 - 8	450419	8 - 30	450567	1 - 3	450815	3 - 13
450172	2 - 8	450421	2 - 7	450567	1 - 5	450815	3 - 12
450177	3 - 10	450422	2 - 8	450568	21 - 91	450818	4 - 16
450179	2 - 7	450426	6 - 21	450571	4 - 15	450818	1 - 5

PART NO.	GROUP AND PAGE NO.	PART NO.	GROUP AND PAGE NO.	PART NO.	GROUP AND PAGE NO.	PART NO.	GROUP AND PAGE NO.
450827	8 - 31	451548	1 - 5	452528	5 - 17	453167	17 - 74
450830	10 - 46	451549	1 - 5	452529	16 - 63	453167	17 - 71
450831	3 - 11	451550	1 - 5	452530	16 - 65	453168	17 - 74
450837	17 - 72	451551	3 - 13	452535	16 - 63	453168	17 - 71
450839	17 - 73	451551	3 - 12	452554	16 - 65	453178	17 - 74
450840	17 - 73	451552	3 - 13	452561	16 - 63	453178	17 - 71
450842	17 - 74	451552	3 - 12	452562	16 - 63	453179	17 - 74
450842	1 - 3	451553	3 - 13	452564	16 - 64	453179	17 - 71
450843	17 - 74	451553	3 - 12	452568	16 - 63	453180	17 - 75
450843	1 - 3	451554	21 - 91	452572	16 - 67	453180	17 - 71
450856	8 - 28	451555	11 - 51	452572	16 - 67	453181	17 - 75
450861	22 - 93	451556	1 - 5	452608	16 - 65	453181	17 - 71
450889	3 - 9	451556	1 - 5	452613	16 - 63	453183	17 - 71
450889	3 - 9	451556	1 - 5	452614	16 - 63	453184	17 - 76
450891	23 - 95	451556	1 - 5	452616	16 - 64	453184	17 - 71
450898	5 - 18	451557	1 - 5	452617	16 - 64	453185	17 - 76
450908	10 - 48	451557	1 - 5	452618	16 - 64	453185	17 - 71
450916	9 - 41	451557	1 - 5	452626	16 - 64	453186	12 - 54
450917	17 - 76	451568	1 - 5	452642	10 - 48	453187	17 - 71
450919	9 - 42	451569	1 - 5	452655	16 - 65	453188	17 - 75
450934	17 - 72	451570	1 - 5	452786	18 - 79	453189	17 - 71
450936	23 - 95	451572	15 - 61	452790	19 - 84	453191	18 - 79
450948	9 - 41	451572	16 - 63	452793	18 - 79	453194	17 - 71
450949	9 - 41	451573	15 - 61	452794	18 - 79	453198	5 - 19
450953	19 - 81	451590	8 - 28	452796	18 - 79	453198	1 - 5
450961	8 - 27	451593	10 - 47	452796	1 - 3	453199	17 - 76
450976	9 - 41	451600	8 - 29	452796	1 - 5	453200	17 - 71
450979	3 - 9	451616	10 - 47	452803	19 - 82	453201	17 - 71
450979	3 - 11	451617	8 - 31	452803	1 - 5	453203	19 - 88
450989	14 - 59	451652	22 - 93	452805	17 - 71	453212	16 - 70
451013	17 - 73	451653	17 - 73	452806	18 - 79	453215	17 - 71
451030	15 - 61	451654	17 - 73	452808	17 - 71	453216	17 - 71
451030	7 - 23	451655	17 - 73	452809	8 - 31	453390	16 - 64
451040	10 - 46	451659	17 - 75	452811	8 - 32	453391	23 - 95
451049	9 - 41	451659	17 - 73	452813	8 - 32	453397	16 - 66
451053	23 - 95	451659	17 - 73	452814	17 - 71	453404	10 - 48
451060	17 - 73	451686	23 - 95	452815	7 - 24	453405	16 - 66
451064	10 - 46	451880	17 - 75	452910	20 - 89	453428	16 - 64
451065	8 - 28	451880	17 - 73	452913	20 - 89	453437	16 - 67
451075	15 - 61	451880	17 - 73	453037	16 - 64	453443	16 - 64
451092	8 - 28	451880	17 - 73	453046	18 - 80	453444	16 - 64
451099	20 - 89	451881	17 - 76	453047	17 - 71	453446	16 - 68
451100	20 - 89	451887	1 - 5	453048	17 - 73	453447	16 - 66
451103	20 - 89	451888	1 - 5	453049	17 - 71	453452	16 - 66
451110	23 - 95	451893	8 - 29	453059	16 - 67	453454	16 - 68
451111	13 - 56	451907	14 - 59	453061	16 - 67	453461	16 - 67
451112	13 - 56	451912	7 - 25	453061	16 - 67	453470	16 - 66
451113	13 - 56	451913	3 - 11	453063	16 - 64	453477	16 - 66
451114	13 - 56	451914	9 - 41	453064	16 - 64	453504	9 - 42
451123	10 - 46	451915	9 - 41	453066	16 - 64	453505	10 - 48
451125	23 - 95	451919	17 - 76	453067	16 - 64	453506	7 - 24
451126	9 - 41	451921	9 - 41	453084	16 - 64	453509	7 - 25
451127	17 - 73	451922	17 - 71	453085	16 - 64	453510	5 - 19
451128	8 - 28	452220	3 - 12	453091	16 - 64	453511	21 - 91
451129	17 - 72	452368	5 - 19	453101	16 - 64	453512	15 - 61
451134	4 - 15	452368	1 - 5	453106	16 - 65	453512	16 - 63
451135	4 - 15	452382	17 - 71	453112	16 - 64	453513	22 - 94
451135	1 - 3	452384	15 - 61	453119	16 - 67	453514	18 - 79
451135	1 - 5	452385	15 - 61	453120	16 - 67	453514	1 - 5
451140	15 - 61	452387	17 - 74	453130	16 - 64	453515	17 - 72
451142	15 - 61	452388	17 - 74	453133	16 - 66	453516	17 - 72
451147	8 - 32	452390	19 - 81	453134	16 - 64	453518	10 - 45
451148	16 - 64	452391	10 - 48	453135	16 - 64	453519	17 - 75
451148	1 - 5	452392	10 - 48	453140	16 - 66	453520	17 - 71
451207	8 - 35	452393	13 - 56	453144	16 - 63	453521	7 - 25
451208	8 - 32	452394	19 - 87	453144	7 - 24	453522	23 - 95
451212	17 - 74	452395	3 - 13	453147	17 - 77	453522	10 - 48
451271	15 - 61	452395	3 - 12	453148	17 - 76	453523	8 - 38
451290	9 - 41	452396	23 - 95	453149	17 - 77	453523	1 - 5
451513	10 - 47	452397	7 - 23	453154	17 - 77	453524	8 - 38
451529	11 - 51	452397	1 - 3	453157	16 - 63	453525	8 - 38
451530	8 - 35	452397	1 - 5	453160	8 - 32	453526	8 - 38
451531	8 - 35	452399	15 - 61	453160	1 - 5	453527	8 - 38
451537	20 - 89	452400	19 - 88	453161	17 - 71	453528	8 - 38
451538	20 - 89	452457	8 - 29	453163	16 - 67	453529	8 - 38
451545	23 - 95	452507	8 - 34	453164	17 - 74	453530	8 - 38
451546	23 - 95	452527	16 - 63	453164	17 - 71	453531	8 - 38
451547	1 - 5	452528	16 - 63	453165	17 - 72	453536	11 - 52

PART NO.	GROUP AND PAGE NO.	PART NO.	GROUP AND PAGE NO.	PART NO.	GROUP AND PAGE NO.	PART NO.	GROUP AND PAGE NO.
453536	1 - 5	453738	16 - 69	454332	1 - 5	460879	18 - 79
453537	19 - 81	453739	16 - 68	454333	13 - 55	460880	18 - 79
453538	19 - 87	453740	16 - 68	454333	1 - 5	460881	8 - 37
453539	9 - 42	453757	16 - 66	454334	13 - 56	460892	3 - 10
453540	18 - 79	453757	16 - 67	454334	1 - 5	460893	19 - 82
453541	19 - 87	453758	16 - 64	454335	13 - 55	460896	23 - 95
453542	19 - 87	453762	16 - 69	454335	13 - 56	460947	3 - 11
453543	9 - 43	453766	16 - 64	454337	21 - 91	460961	8 - 29
453545	18 - 79	453769	16 - 66	454350	3 - 10	460964	17 - 74
453548	17 - 74	453770	16 - 68	454351	22 - 93	460966	5 - 18
453549	17 - 77	453772	16 - 67	454352	22 - 93	460987	14 - 59
453550	17 - 71	453773	16 - 64	454352	1 - 3	460988	14 - 59
453551	17 - 72	453774	16 - 64	454353	3 - 10	460996	22 - 94
453552	17 - 72	453777	16 - 66	454353	1 - 3	460997	10 - 46
453553	17 - 72	453778	16 - 64	454353	1 - 5	461010	15 - 61
453554	18 - 79	453780	16 - 67	454354	10 - 47	461011	15 - 61
453555	18 - 79	453787	16 - 66	454355	23 - 95	461014	15 - 61
453558	23 - 95	453808	16 - 67	460005	8 - 29	461015	15 - 61
453559	23 - 95	453808	16 - 67	460008	8 - 29	461016	15 - 61
453560	22 - 94	453834	16 - 68	460025	8 - 29	461031	17 - 72
453561	22 - 94	453836	16 - 68	460028	8 - 31	461036	21 - 91
453562	22 - 94	453842	16 - 66	460028	1 - 5	461038	21 - 91
453570	9 - 43	453844	16 - 66	460064	19 - 82	461043	7 - 23
453571	18 - 80	453868	16 - 63	460107	6 - 22	461044	7 - 23
453573	18 - 80	453879	16 - 66	460108	10 - 48	461046	7 - 23
453574	18 - 80	453888	16 - 64	460139	7 - 25	461058	5 - 18
453575	5 - 18	453889	16 - 66	460169	7 - 25	461059	5 - 18
453576	19 - 87	453900	16 - 69	460178	20 - 89	461060	7 - 23
453577	19 - 87	453903	16 - 69	460192	8 - 29	461061	7 - 23
453578	19 - 87	453904	16 - 66	460193	8 - 29	461063	15 - 61
453581	1 - 5	453917	16 - 69	460194	13 - 55	461064	10 - 47
453582	1 - 5	453917	16 - 69	460196	19 - 81	461065	10 - 47
453583	1 - 5	453918	16 - 69	460240	10 - 47	461068	19 - 81
453585	18 - 79	453919	16 - 69	460258	4 - 15	461070	5 - 18
453586	18 - 80	453920	16 - 69	460260	19 - 82	461071	5 - 18
453587	16 - 67	453921	16 - 69	460261	19 - 88	461072	7 - 23
453588	16 - 64	453922	16 - 69	460274	17 - 72	461073	7 - 23
453592	18 - 80	453923	16 - 69	460290	3 - 14	461074	7 - 23
453594	22 - 93	453924	16 - 69	460294	5 - 18	461075	5 - 18
453595	18 - 80	453925	16 - 69	460296	23 - 95	461076	5 - 18
453596	19 - 86	453926	16 - 69	460303	7 - 26	461083	10 - 47
453599	19 - 82	453927	16 - 69	460303	1 - 5	461086	17 - 75
453600	19 - 83	453928	16 - 69	460304	3 - 9	461087	17 - 76
453604	8 - 37	453929	16 - 69	460304	1 - 5	461090	17 - 75
453604	1 - 5	453930	16 - 69	460305	3 - 9	461090	17 - 71
453607	3 - 11	453931	16 - 69	460305	1 - 5	461091	17 - 75
453608	3 - 13	453932	16 - 69	460306	3 - 9	461092	17 - 74
453609	3 - 13	453933	16 - 69	460306	1 - 5	461108	19 - 85
453610	19 - 83	453934	16 - 69	460307	3 - 9	461110	15 - 61
453611	19 - 87	453935	16 - 69	460307	1 - 5	461110	7 - 23
453612	16 - 64	453936	16 - 69	460308	3 - 9	461117	9 - 41
453614	18 - 79	453937	16 - 69	460308	1 - 5	461118	17 - 75
453618	16 - 65	453938	16 - 69	460309	3 - 9	461118	17 - 75
453625	19 - 87	453942	16 - 67	460309	1 - 5	461119	17 - 75
453630	19 - 87	453944	16 - 67	460310	10 - 47	461119	17 - 75
453631	10 - 49	453944	16 - 67	460311	3 - 9	461119	17 - 71
453638	23 - 95	453944	16 - 67	460311	1 - 5	461119	17 - 73
453639	23 - 95	453944	16 - 67	460312	3 - 12	461119	17 - 73
453640	23 - 95	453944	16 - 67	460312	1 - 5	461119	17 - 73
453641	23 - 95	453954	16 - 67	460313	3 - 12	461119	17 - 73
453642	23 - 95	454065	14 - 59	460314	3 - 12	461121	21 - 91
453643	23 - 95	454065	7 - 23	460314	1 - 5	461122	21 - 91
453646	19 - 86	454065	1 - 5	460315	7 - 26	461128	3 - 10
453648	18 - 80	454105	19 - 83	460315	1 - 5	461129	3 - 10
453649	19 - 82	454302	2 - 7	460464	3 - 9	461130	10 - 49
453663	1 - 5	454304	19 - 81	460622	5 - 19	461131	10 - 47
453670	19 - 87	454312	5 - 19	460624	19 - 81	461137	3 - 11
453674	19 - 86	454321	8 - 29	460626	17 - 76	461141	9 - 41
453675	17 - 71	454323	10 - 45	460627	19 - 81	461158	5 - 19
453678	19 - 85	454325	8 - 31	460670	17 - 72	461159	17 - 74
453693	10 - 45	454326	8 - 29	460805	17 - 72	461159	17 - 71
453696	19 - 87	454326	1 - 3	460807	5 - 17	461161	7 - 25
453699	17 - 77	454326	1 - 5	460808	5 - 17	461162	8 - 27
453711	16 - 63	454326	1 - 5	460811	4 - 15	461165	19 - 82
453712	16 - 69	454328	22 - 93	460812	3 - 12	461175	17 - 74
453721	16 - 68	454329	3 - 9	460813	10 - 45	461180	10 - 47
453722	16 - 68	454329	3 - 9	460820	7 - 23	461193	8 - 34
453737	16 - 69	454332	13 - 57	460870	9 - 41	461198	19 - 84

PART NO.	GROUP AND PAGE NO.	PART NO.	GROUP AND PAGE NO.	PART NO.	GROUP AND PAGE NO.	PART NO.	GROUP AND PAGE NO.
461222	19 - 85	489895	3 - 14	634429	19 - 88	821079	19 - 84
461224	19 - 85	489898	9 - 41	634499	19 - 88	821080	19 - 84
461225	19 - 85	489902	3 - 10	634779	23 - 95	821081	19 - 84
461226	4 - 15	489905	5 - 17	637038	3 - 10	821083	19 - 84
461228	4 - 15	489905	1 - 3	637931	8 - 32	821084	19 - 84
461228	1 - 3	489929	10 - 45	640255	11 - 52	821099	19 - 84
461229	19 - 87	489929	3 - 12	640782	8 - 34	825369	19 - 88
461230	19 - 87	489942	7 - 24	640783	8 - 34	827047	19 - 88
461235	15 - 61	489942	1 - 3	640784	8 - 34	829117	16 - 64
461247	19 - 86	489944	19 - 82	640785	8 - 34	829118	16 - 64
461252	19 - 84	489945	12 - 54	640786	8 - 34	829119	16 - 64
461253	19 - 84	489949	7 - 24	640830	8 - 34	830292	19 - 84
461254	19 - 84	489949	1 - 3	641155	8 - 35	832502	19 - 84
461255	19 - 84	489958	17 - 73	641458	23 - 95	834286	23 - 95
461256	19 - 84	489959	17 - 73	641462	23 - 95	834308	8 - 33
461257	19 - 84	489967	5 - 17	641503	8 - 34	834327	3 - 14
461258	19 - 84	489968	5 - 18	641508	8 - 36	837890	19 - 88
461259	19 - 84	489969	5 - 18	647228	19 - 88	838163	19 - 88
461262	15 - 62	489976	13 - 56	647521	19 - 88	838173	19 - 88
461262	15 - 62	489982	4 - 15	647625	19 - 88	845430	8 - 35
461262	1 - 5	489983	10 - 45	650013	7 - 23	847859	8 - 35
461274	17 - 76	490581	13 - 55	650823	8 - 36	848204	9 - 42
461275	3 - 11	490606	5 - 17	650867	8 - 36	848205	9 - 42
461305	23 - 95	503928	19 - 85	667329	9 - 41	852342	8 - 39
461392	8 - 39	505289	4 - 16	674027	19 - 85	855546	22 - 93
461393	13 - 55	512881	17 - 73	674028	19 - 85	856170	8 - 31
461394	13 - 56	512882	17 - 73	674029	19 - 85	856381	23 - 95
461395	8 - 33	512885	17 - 76	674030	19 - 85	856481	3 - 10
461420	7 - 23	512886	17 - 76	680763	19 - 85	856481	1 - 5
461445	19 - 85	512888	17 - 74	701329	22 - 94	857385	8 - 35
461450	9 - 43	512889	17 - 75	727468	19 - 82	857434	19 - 86
461453	8 - 33	512890	17 - 75	747579	19 - 84	857440	8 - 36
461545	16 - 67	512892	13 - 56	761325	19 - 81	857450	8 - 36
461556	16 - 67	512893	10 - 47	762637	9 - 42	857459	9 - 41
461589	13 - 55	556801	19 - 88	771448	13 - 56	889524	23 - 95
461599	13 - 56	556944	21 - 91	771488	1 - 3	961343	10 - 45
461616	8 - 39	556944	11 - 52	771494	23 - 95	963400	22 - 94
461617	3 - 9	556945	11 - 52	771625	23 - 95	1000502	8 - 33
461621	23 - 95	596338	23 - 95	771627	23 - 95	1012444	1 - 5
461707	8 - 29	596763	23 - 95	771674	23 - 95	1018992	21 - 91
471519	23 - 95	600914	8 - 29	771754	23 - 95	1018992	11 - 52
472752	8 - 31	603716	23 - 95	771821	23 - 95	1018992	11 - 51
477169	8 - 34	603717	23 - 95	771847	23 - 95	1018992	1 - 3
477567	23 - 95	603718	23 - 95	802000	19 - 82	1143198	16 - 65
489017	5 - 17	603910	23 - 95	804460	8 - 35	1145391	10 - 48
489019	7 - 24	605901	8 - 33	804720	8 - 30	1161480	19 - 85
489026	11 - 51	605901	1 - 5	806533	9 - 41	1272825	19 - 85
489029	11 - 51	605902	3 - 9	806565	8 - 37	1280017	23 - 95
489036	4 - 15	605902	1 - 5	808540	8 - 36	1280018	23 - 95
489036	1 - 3	605903	3 - 10	815094	16 - 65	1280441	23 - 95
489067	12 - 53	605903	1 - 5	815095	16 - 65	1280442	23 - 95
489076	14 - 59	605904	5 - 19	815096	16 - 65	1280443	23 - 95
489076	6 - 21	605904	1 - 5	815097	16 - 65	1280444	23 - 95
489136	4 - 15	605905	8 - 29	815098	16 - 65	1550709	19 - 88
489146	4 - 15	605906	10 - 48	815099	16 - 65	1550710	19 - 88
489150	14 - 59	605907	1 - 5	815100	16 - 65	1765342	19 - 86
489150	8 - 31	605908	7 - 26	815101	16 - 65	1978459	7 - 23
489150	1 - 3	605908	1 - 5	815102	16 - 65	2058581	10 - 45
489156	10 - 45	605960	23 - 95	815103	16 - 65	2086587	19 - 82
489174	3 - 11	605967	10 - 48	815104	16 - 65	2100937	19 - 85
489185	9 - 42	608183	8 - 29	815105	16 - 65	2102025	13 - 56
489185	1 - 3	610094	8 - 32	815106	16 - 65	2106718	8 - 33
489193	5 - 19	610147	8 - 30	815107	16 - 65	2106774	23 - 95
489202	19 - 81	610692	8 - 30	815108	16 - 65	2108001	3 - 10
489203	19 - 81	612704	8 - 31	815109	16 - 65	2108006	10 - 48
489239	3 - 10	613898	8 - 30	815110	16 - 65	2108010	11 - 51
489242	5 - 19	615960	23 - 95	815111	16 - 65	2108014	21 - 91
489242	1 - 3	616185	2 - 8	815112	16 - 65	2108014	5 - 19
489824	8 - 29	619022	23 - 95	815113	16 - 65	2108016	10 - 48
489840	3 - 10	622285	19 - 83	815905	16 - 68	2108019	16 - 64
489841	3 - 10	625287	8 - 34	815906	16 - 68	2108021	12 - 53
489857	3 - 9	626532	8 - 27	815907	16 - 68	2108023	10 - 49
489878	3 - 9	626533	8 - 27	817971	17 - 71	2108024	21 - 91
489881	13 - 55	626537	8 - 27	820324	19 - 88	2108025	21 - 91
489881	1 - 3	627700	8 - 30	821050	19 - 84	2108025	11 - 51
489882	13 - 55	628848	8 - 34	821075	19 - 84	2108027	21 - 91
489882	1 - 3	628969	23 - 95	821077	19 - 84	2108036	21 - 91
489883	13 - 55	630237	8 - 36	821078	19 - 84	2108039	9 - 43

PART NO.	GROUP AND PAGE NO.	PART NO.	GROUP AND PAGE NO.	PART NO.	GROUP AND PAGE NO.	PART NO.	GROUP AND PAGE NO.
2108040	21 - 91	2108914	3 - 11	2200166	8 - 34	2508925	10 - 49
2108040	3 - 11	2108916	10 - 48	2200174	10 - 49	2512088	9 - 43
2108041	21 - 91	2108930	11 - 52	2200176	3 - 14	2512794	9 - 43
2108049	17 - 73	2108930	11 - 52	2200191	10 - 49	2513000	19 - 86
2108050	17 - 73	2109829	11 - 51	2200194	3 - 9	2513154	9 - 42
2108051	21 - 91	2111942	9 - 43	2200200	23 - 95	2513590	23 - 95
2108055	21 - 91	2114417	22 - 94	2200201	8 - 34	2513590	11 - 52
2108075	21 - 91	2115252	23 - 95	2200204	3 - 14	2515226	8 - 39
2108142	8 - 27	2115444	23 - 95	2200205	7 - 24	2515283	9 - 43
2108151	19 - 83	2121394	3 - 13	2200209	8 - 37	2515376	8 - 38
2108156	17 - 73	2121874	21 - 91	2200294	9 - 42	2515390	3 - 14
2108157	17 - 73	2123106	11 - 52	2200326	8 - 38	2515401	7 - 26
2108180	23 - 95	2124529	17 - 73	2200343	10 - 49	2517647	8 - 39
2108181	23 - 95	2124530	17 - 73	2200345	19 - 81	2517648	8 - 38
2108184	23 - 95	2124599	17 - 74	2200420	19 - 83	2517722	8 - 39
2108268	21 - 91	2124599	1 - 5	2200430	8 - 35	2517735	8 - 38
2108305	5 - 18	2127714	23 - 95	2200432	8 - 35	2518318	16 - 69
2108306	3 - 12	2127794	23 - 95	2200440	8 - 35	2528888	20 - 89
2108311	21 - 91	2127892	7 - 25	2200464	3 - 13	2533723	8 - 39
2108312	21 - 91	2129264	17 - 73	2200590	8 - 37	2533723	3 - 14
2108312	9 - 43	2133355	23 - 95	2229268	8 - 38	2536581	8 - 35
2108313	21 - 91	2134643	23 - 95	2229272	8 - 38	2536582	8 - 35
2108314	21 - 91	2155623	10 - 48	2244061	3 - 9	2536583	8 - 35
2108315	3 - 12	2155966	23 - 95	2244974	19 - 81	2536591	8 - 38
2108315	3 - 13	2162567	11 - 52	2245008	11 - 52	2537301	19 - 83
2108398	7 - 24	2162866	10 - 48	2247662	8 - 36	2537550	8 - 38
2108433	21 - 91	2164584	23 - 95	2248032	8 - 38	2537562	10 - 46
2108435	21 - 91	2175928	23 - 95	2248040	8 - 38	2538009	9 - 43
2108436	21 - 91	2176205	16 - 64	2248078	23 - 95	2538084	9 - 41
2108466	21 - 91	2182906	16 - 65	2249715	10 - 49	2538137	9 - 41
2108467	3 - 12	2182907	16 - 63	2250852	19 - 88	2570250	19 - 87
2108470	21 - 91	2183478	19 - 86	2258530	15 - 62	2572882	8 - 36
2108474	11 - 51	2191421	8 - 33	2286189	10 - 49	2597940	8 - 28
2108478	21 - 91	2193977	19 - 88	2286679	9 - 43	2597962	8 - 28
2108481	21 - 91	2197195	4 - 15	2360000	16 - 69	2597967	9 - 43
2108486	21 - 91	2197864	17 - 73	2360001	16 - 69	2597969	9 - 43
2108490	3 - 12	2200001	19 - 83	2360002	16 - 69	2597970	9 - 43
2108490	3 - 13	2200006	8 - 39	2360003	16 - 69	2597971	9 - 43
2108491	10 - 47	2200007	8 - 39	2360004	16 - 69	2598040	8 - 35
2108493	7 - 24	2200008	10 - 47	2360005	16 - 69	2598041	8 - 35
2108495	8 - 30	2200012	19 - 85	2360006	16 - 69	2598042	8 - 35
2108496	8 - 30	2200014	19 - 85	2360007	16 - 69	2598179	8 - 35
2108497	8 - 30	2200018	19 - 83	2360008	16 - 69	2598187	9 - 43
2108498	3 - 12	2200022	10 - 49	2360009	16 - 69	2600559	9 - 41
2108507	8 - 34	2200026	7 - 25	2360010	16 - 69	2604621	18 - 80
2108538	19 - 88	2200028	8 - 37	2360011	16 - 69	2631570	8 - 38
2108570	21 - 91	2200031	3 - 10	2360012	16 - 69	2646290	22 - 94A
2108576	8 - 33	2200032	23 - 95	2360013	16 - 69	2646774	18 - 80
2108577	8 - 33	2200033	11 - 52	2360014	16 - 69	2703540	16 - 64
2108578	8 - 33	2200040	9 - 42	2360015	16 - 69	2703977	19 - 86
2108591	15 - 61	2200041	23 - 95	2360016	16 - 69	2703978	19 - 86
2108594	15 - 61	2200043	23 - 95	2360017	16 - 69	2704117	7 - 26
2108595	8 - 38	2200045	7 - 23	2360018	16 - 69	2728154	22 - 94
2108617	9 - 41	2200050	8 - 30	2360019	16 - 69	2728186	10 - 45
2108621	8 - 36	2200051	3 - 12	2360020	16 - 69	2728218	19 - 87
2108625	8 - 32	2200052	17 - 76	2360078	16 - 69	2728225	16 - 69
2108626	3 - 12	2200054	19 - 86	2360089	16 - 69	2984249	19 - 88
2108627	8 - 30	2200057	8 - 39	2360173	8 - 38	3007296	8 - 32
2108633	8 - 32	2200058	8 - 37	2360173	8 - 36	4098027	11 - 52
2108634	8 - 32	2200059	10 - 49	2360328	16 - 67	4111067	19 - 82
2108721	23 - 95	2200063	10 - 48	2360329	16 - 67	4116511	10 - 49
2108722	23 - 95	2200066	7 - 26	2360330	16 - 67	4116650	10 - 49
2108723	23 - 95	2200079	17 - 73	2360331	16 - 67	4117310	19 - 83
2108724	23 - 95	2200100	19 - 83	2360332	16 - 67	4121047	17 - 75
2108733	7 - 24	2200101	5 - 19	2360333	16 - 67	4121075	17 - 75
2108746	21 - 91	2200102	8 - 30	2360355	16 - 68	4210110	19 - 84
2108747	21 - 91	2200103	7 - 26	2360370	16 - 69	4261006	17 - 76
2108766	4 - 16	2200104	3 - 13	2360370	16 - 69	4261006	1 - 3
2108767	3 - 13	2200105	8 - 37	2360383	16 - 65	4261008	1 - 3
2108770	15 - 61	2200106	11 - 51	2360390	16 - 70	4261050	8 - 30
2108771	15 - 61	2200109	8 - 37	2414943	17 - 73	4261062	22 - 94
2108790	12 - 53	2200111	8 - 37	2491996	19 - 84	4261062	15 - 61
2108791	8 - 34	2200113	8 - 37	2492000	19 - 84	4261069	22 - 93
2108860	16 - 65	2200118	23 - 95	2492775	19 - 84	4261074	19 - 84
2108876	19 - 84	2200119	8 - 37	2494907	7 - 26	4261075	19 - 84
2108889	15 - 61	2200139	4 - 16	2506166	19 - 88	4261076	10 - 45
2108912	8 - 32	2200144	8 - 37	2507587	11 - 52	4261076	1 - 3
2108913	8 - 32	2200161	3 - 14	2508924	23 - 95	4261079	4 - 16

PART NO.	GROUP AND PAGE NO.	PART NO.	GROUP AND PAGE NO.	PART NO.	GROUP AND PAGE NO.	PART NO.	GROUP AND PAGE NO.
4261080	17 - 75	5392431	13 - 57	8019963	19 - 81		
4261080	17 - 73	5392432	13 - 57	8021710	4 - 16		
4261080	1 - 3	5392433	13 - 57	8021711	3 - 11		
4261081	17 - 73	5392434	13 - 57	8026752	23 - 95		
4261085	12 - 53	5392435	23 - 95	8027615	16 - 65		
4261088	22 - 93	5392438	23 - 95	8027616	16 - 65		
4261089	22 - 94	5417910	19 - 83				
4261089	1 - 3	5417978	19 - 88				
4261090	3 - 9	5420330	19 - 83				
4261091	19 - 84	5442557	19 - 83				
4261093	17 - 73	5442582	19 - 83				
4261094	19 - 84	5442707	19 - 83				
4261101	12 - 53	5442710	19 - 83				
4261101	1 - 3	5442712	19 - 83				
4261102	22 - 94	5442715	19 - 83				
4261102	1 - 3	5442867	23 - 95				
4261104	22 - 93	5442868	23 - 95				
4261104	1 - 3	5471459	19 - 87				
4261105	1 - 3	5480396	23 - 95				
4261107	5 - 19	5488710	19 - 88				
4261108	17 - 73	5488711	19 - 88				
4261108	1 - 3	5488712	19 - 88				
4261109	17 - 73	5495151	17 - 71				
4261109	1 - 3	5495166	17 - 77				
4261114	22 - 94	5495384	9 - 43				
4261114	16 - 65	5495385	9 - 43				
4261124	10 - 49	5496935	19 - 82				
4261147	22 - 94	5500746	19 - 86				
4261147	16 - 65	5500747	19 - 86				
4261148	22 - 94	5500748	19 - 86				
4261148	1 - 3	5500749	19 - 86				
4351049	6 - 21	5500750	17 - 71				
4351130	6 - 21	5500864	17 - 76				
4351136	6 - 21	5500898	17 - 71				
4351137	6 - 21	5500899	17 - 71				
4351138	6 - 21	5500900	17 - 71				
4351140	6 - 21	5500901	17 - 71				
4351141	6 - 21	5500902	17 - 71				
4531166	6 - 22	5500903	17 - 71				
4611153	9 - 42	5702426	19 - 83				
4621006	17 - 75	5712439	19 - 85				
4621124	10 - 49	5714188	19 - 88				
4690840	6 - 22	5715008	23 - 95				
4691431	11 - 52	5715009	23 - 95				
5144304	23 - 95	5715010	23 - 95				
5151439	13 - 57	5715011	23 - 95				
5153373	19 - 85	5724376	19 - 88				
5153375	19 - 85	5728554	8 - 37				
5155335	19 - 85	5740506	19 - 88				
5155336	19 - 85	5740508	19 - 88				
5155337	19 - 85	5740509	19 - 88				
5159315	19 - 88	5740511	19 - 88				
5180928	19 - 88	5740551	19 - 88				
5222564	19 - 82	5750869	19 - 88				
5230032	13 - 56	5750870	19 - 88				
5230053	17 - 74	5771914	19 - 88				
5230054	17 - 74	5800613	16 - 64				
5230092	5 - 18	5801067	16 - 65				
5246313	23 - 95	5803975	16 - 65				
5246316	23 - 95	5803976	16 - 65				
5258784	9 - 42	5808354	15 - 62				
5258785	18 - 79	5808897	16 - 67				
5258786	9 - 43	5831638	8 - 32				
5258789	19 - 86	5831644	8 - 36				
5258790	19 - 86	5851882	16 - 65				
5311035	19 - 88	5853341	16 - 68				
5320042	23 - 95	5861448	19 - 88				
5352274	16 - 63	5861452	19 - 88				
5353889	16 - 65	5888206	19 - 86				
5353889	16 - 67	5888962	16 - 64				
5356195	19 - 88	5888970	16 - 64				
5367876	19 - 88	5888972	16 - 64				
5373693	19 - 88	5888976	16 - 64				
5390876	19 - 83	5994204	8 - 35				
5391007	10 - 46	5998763	16 - 69				
5392366	9 - 43	6514016	22 - 93				
5392428	13 - 55	7030589	3 - 11				
5392430	13 - 57	8012757	19 - 82				



Order No. S131-0037-1

Your views about this publication may help improve its usefulness; this form will be sent to the author's department for appropriate action. Using this form to request system assistance or additional publications will delay response, however. For more direct handling of such request, please contact your IBM representative or the IBM Branch Office serving your locality.

Possible topics for comment are:

Clarity Accuracy Completeness Organization Index Figures Examples Legibility

Cut or Fold Along This Line

What is your occupation? -----

Number of latest Technical Newsletter (if any) concerning this publication: -----

Please indicate in the space below if you wish a reply.

Thank you for your cooperation. No postage stamp necessary if mailed in the U.S.A. (Elsewhere, an IBM office or representative will be happy to forward your comments.)

YOUR COMMENTS, PLEASE . . .

Your answers to the questions on the back of this form, together with your comments, help us produce better publications for your use. Each reply is carefully reviewed by the persons responsible for writing and publishing this material. All comments and suggestions become the property of IBM.

Please note: Requests for copies of publications and for assistance in using your IBM system should be directed to your IBM representative or to the IBM sales office serving your locality.

Fold

Fold

FIRST CLASS
PERMIT NO. 569
RESEARCH TRIANGLE PARK
NORTH CAROLINA

BUSINESS REPLY MAIL
NO POSTAGE STAMP NECESSARY IF MAILED IN U. S. A.

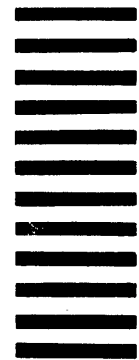

POSTAGE WILL BE PAID BY . . .

IBM Corporation
P. O. Box 12195
Research Triangle Park
North Carolina 27709

Attention: Publications Center, Dept. E01

Fold

Fold



International Business Machines Corporation
Data Processing Division
1133 Westchester Avenue, White Plains, New York 10604
(U.S.A. only)

IBM World Trade Corporation
821 United Nations Plaza, New York, New York 10017
(International)

Cut Along Line

Tools and Test Equipment, Volume 1 (PC) Printed in U.S.A. S131-0037-1

2

3

4

5

S131-0037-1



International Business Machines Corporation
Data Processing Division
1133 Westchester Avenue, White Plains, New York 10604
(U.S.A. only)

IBM World Trade Corporation
821 United Nations Plaza, New York, New York 10017
(International)